



# **MS-CF16 V3.0**

## **Industrial Computer Board**

User Guide

# Contents

Regulatory Notices.....	4
Safety Information .....	7
Specifications .....	9
Motherboard Overview .....	11
Rear I/O Panel.....	12
HDMI™ Connector .....	12
USB 10Gbps Port.....	12
USB 5 Gbps Port.....	12
GbE RJ-45 LAN Jack .....	12
ME Overview .....	13
Board Dimension .....	13
Suggested Chassis I/O Gap Dimension .....	14
Storage .....	16
Expansion Slots .....	17
Connectors .....	19
Power Connectors.....	19
Cooling Connector .....	20
Connectors .....	20
Audio Connector .....	21
Graphics Connectors .....	22
USB Connector.....	25
Other Connectors.....	26
Jumpers .....	31

## Revision

V2.3, 2026/04

BIOS Setup.....	32
Entering Setup .....	32
Control Keys.....	33
Getting Help .....	33
Main Menu .....	33
Sub-Menu .....	33
General Help <F1>.....	33
The Menu Bar .....	34
Main.....	35
Advanced .....	36
Boot .....	45
Security .....	46
Chipset .....	54
Power .....	55
Save & Exit.....	56
Audio Driver Setup.....	57
Installing the Intel® SST Audio Driver.....	57
GPIO WDT Programming.....	59
Abstract .....	59
1. General Purpose IO - GPIO / DIO.....	60
2. Watchdog Timer - WDT .....	62

# Regulatory Notices

## CE Conformity

This product has been tested and found to comply with the harmonized standards for Information Technology Equipment published under Directives of Official Journal of the European Union.



## FCC-B Radio Frequency Interference Statement

This equipment has been tested and found to comply with the limits for a Class B digital device, pursuant to Part 15 of the FCC Rules. These limits are designed to provide reasonable protection against harmful interference in a residential installation. This equipment generates, uses and can radiate radio frequency energy and, if not installed and used in accordance with the instruction manual, may cause harmful interference to radio communications. However, there is no guarantee that interference will not occur in a particular installation. If this equipment does cause harmful interference to radio or television reception, which can be determined by turning the equipment off and on, the user is encouraged to try to correct the interference by one or more of the measures listed below:



- Reorient or relocate the receiving antenna.
- Increase the separation between the equipment and receiver.
- Connect the equipment into an outlet on a circuit different from that to which the receiver is connected.
- Consult the dealer or an experienced radio/television technician for help.

### Notice 1

The changes or modifications not expressly approved by the party responsible for compliance could void the user's authority to operate the equipment.

### Notice 2

Shielded interface cables and AC power cord, if any, must be used in order to comply with the emission limits.

This device complies with Part 15 of the FCC Rules. Operation is subject to the following two conditions:

1. This device may not cause harmful interference, and
2. This device must accept any interference received, including interference that may cause undesired operation.

## WEEE Statement

**European Union:** This symbol on the product indicates that this product cannot be discarded as municipal waste. Instead, it is your responsibility to dispose of your waste electrical and electronic equipment by handing it over to a designated collection point for recycling. For more information about where you can drop off your waste equipment for recycling, please contact your local city office, your household waste disposal service or the shop where you purchased the product.



## Chemical Substances Information

In compliance with chemical substances regulations, such as the EU REACH Regulation (Regulation EC No. 1907/2006 of the European Parliament and the Council), MSI provides the information of chemical substances in products at:

<https://csr.msi.com/global/index>

## Battery Information

Please take special precautions if this product comes with a battery.

- Danger of explosion if battery is incorrectly replaced. Replace only with the same or equivalent type recommended by the manufacturer.
- Avoid disposal of a battery into fire or a hot oven, or mechanically crushing or cutting of a battery, which can result in an explosion.
- Avoid leaving a battery in an extremely high temperature or extremely low air pressure environment that can result in an explosion or the leakage of flammable liquid or gas.
- Do not ingest battery. If the coin/button cell battery is swallowed, it can cause severe internal burns and can lead to death. Keep new and used batteries away from children.

### European Union:



Batteries, battery packs, and accumulators should not be disposed of as unsorted household waste. Please use the public collection system to return, recycle, or treat them in compliance with the local regulations.

### BSMI:



廢電池請回收

For better environmental protection, waste batteries should be collected separately for recycling or special disposal.

### California, USA:



The button cell battery may contain perchlorate material and requires special handling when recycled or disposed of in California.

For further information please visit:

<http://www.dtsc.ca.gov/hazardouswaste/perchlorate/>

## Environmental Policy

- The product has been designed to enable proper reuse of parts and recycling and should not be thrown away at its end of life.
- Users should contact the local authorized point of collection for recycling and disposing of their end-of-life products.
- Visit the MSI website <[https://csr.msi.com/global/pevn\\_ewaste](https://csr.msi.com/global/pevn_ewaste)> and locate a nearby distributor for further recycling information.
- Please visit <<https://us.msi.com/page/recycling>> for information regarding the recycling of your product in the US.



## Copyright and Trademarks Notice

**msi**

**MSI**

**微星**

**微星科技**  
MICRO-STAR INTERNATIONAL



Copyright © Micro-Star Int'l Co., Ltd. All rights reserved. The MSI logo used is a registered trademark of Micro-Star Int'l Co., Ltd. All other marks and names mentioned may be trademarks of their respective owners. No warranty as to accuracy or completeness is expressed or implied. MSI reserves the right to make changes to this document without prior notice.

**HDMI**<sup>™</sup>  
HIGH-DEFINITION MULTIMEDIA INTERFACE

The terms HDMI<sup>™</sup>, HDMI<sup>™</sup> High-Definition Multimedia Interface, HDMI<sup>™</sup> Trade dress and the HDMI<sup>™</sup> Logos are trademarks or registered trademarks of HDMI<sup>™</sup> Licensing Administrator, Inc.

## Technical Support

If a problem arises with your product and no solution can be obtained from the user's manual, please contact your place of purchase or local distributor. Alternatively, please visit <https://www.msi.com/support/> for further guidance.

# Safety Information



***Please read and follow these safety instructions carefully before installing, operating or performing maintenance on the equipment.***

## General Safety Instructions

- Always read the safety instructions carefully.
- Keep this User's Manual for future reference.
- Keep this equipment in a dry, humidity-free environment.
- Ensure that all components are securely connected to prevent issues during operation.
- Do not cover the air openings to prevent overheating.
- Avoid spilling liquids into the equipment to prevent damage or electrical shock.
- Do not leave the equipment in an unconditioned environment. Storage temperatures above 60°C (140°F) may cause damage.

## Electrostatic Discharge (ESD) Precautions

The components included in this package are sensitive to electrostatic discharge. Follow these guidelines to prevent ESD-related damage:

- Hold the motherboard by the edges to avoid touching sensitive components.
- Wear an ESD wrist strap. If not available, discharge static electricity by touching a metal object before handling.
- When not installed, store the motherboard in an electrostatic shielding container or place it on an anti-static pad.

## Power Safety

- Always turn off the power supply and unplug the power cord from the outlet before installing or removing any component.
- Ensure the electrical outlet provides the same voltage as indicated on the PSU before connecting.
- Arrange the power cord to avoid tripping hazards or damage. Do not place objects over the power cord.

## **Installation Instructions**

- Lay the equipment on a stable, flat surface before setting it up.
- Before turning on the system, ensure there are no loose screws or metal components on the motherboard or within the system case.
- Do not boot the computer before completing all installations. Premature booting can cause permanent damage to components and pose safety risks.

## **When to Contact Service Personnel**

Immediately consult service personnel if any of the following situations arise:

- The power cord or plug is damaged.
- Liquid has entered the equipment.
- The equipment has been exposed to moisture.
- The equipment does not function as described in the User Guide.
- The equipment has been dropped or physically damaged.
- The equipment shows visible signs of breakage.

# Specifications

Model	Alder Lake-N SKU	Twin Lake SKU	Amston Lake SKU
Dimensions	101(L)mm x 73(W)mm, PICO-ITX		
Processor	<ul style="list-style-type: none"> <li>Intel® IoTG Alder Lake-N, - Processor N97, 4 cores, 12W</li> </ul>	<ul style="list-style-type: none"> <li>Intel® IoTG Twin Lake-N, - Processor N150, 4 cores, 6W</li> </ul>	<ul style="list-style-type: none"> <li>Intel® IoTG Amston Lake, - Atom® x7433RE, 4 cores, 9W</li> </ul>
Chipset	Within processor		
TPM	Infineon® SLB 9672VU2.0		Infineon® SLB 9672XU2.0
Network	<ul style="list-style-type: none"> <li>1 x Realtek® RTL8125BG-CG 2.5GbE LAN</li> <li>1 x Realtek® RTL8111K-CG 1GbE LAN</li> </ul>		<ul style="list-style-type: none"> <li>1 x Realtek® RTL8125BI-CG 2.5GbE LAN</li> <li>1 x Realtek® RTL8111KI-CG 1GbE LAN</li> </ul>
Memory	<ul style="list-style-type: none"> <li>LPDDR5 on board</li> <li>- Single channel DDR5, Non-ECC</li> <li>- Up to 4800 MT/s</li> <li>- Up to 16GB</li> </ul>		
Storage	1 x SATA 3.0 6Gb/s ports		
Expansion Slots	<ul style="list-style-type: none"> <li>1 x M.2 E Key slot (2230) <ul style="list-style-type: none"> <li>- Supports PCIe 3.0 x1, USB 2.0 (480 Mbps) signal</li> </ul> </li> <li>1 x M.2 B Key slot (2242/ 3042) <ul style="list-style-type: none"> <li>- Supports SATA 3.0/ PCIe 3.0 x1, USB 10Gbps &amp; USB 2.0 (480 Mbps) signals</li> <li>- Supports B+M key PCIe 3.0 x1 module</li> <li>- Supports Quectel EM05-G Wi-Fi module with E-SIM</li> </ul> </li> </ul>		
Audio	Realtek® ALC897 High Definition Audio Codec		
Graphics	<ul style="list-style-type: none"> <li>1 x HDMI™ 1.4b up to 3840x2160 @30Hz</li> <li>1 x eDP up to 1920×1080 @60Hz <ul style="list-style-type: none"> <li>- Supports auto switch between eDP &amp; LVDS</li> <li>- Connector shared with LVDS</li> </ul> </li> <li>1 x LVDS up to 1920×1080 @60Hz <ul style="list-style-type: none"> <li>- Supports 18/24-bit dual channel</li> <li>- Supports auto switch between eDP &amp; LVDS</li> <li>- Connector shared with eDP</li> </ul> </li> <li>2 Independent display supported <ul style="list-style-type: none"> <li>- HDMI™ + LVDS/ eDP</li> </ul> </li> </ul>		
Rear Panel Connectors	<ul style="list-style-type: none"> <li>1 x HDMI™ connector (1.4b)</li> <li>1 x 2.5 GbE RJ-45 LAN port</li> <li>1 x 1 GbE RJ-45 LAN port</li> <li>1 x USB 10Gbps Type-A port</li> <li>1 x USB 5Gbps Type-A port</li> </ul>		
Internal USB Connectors	1 x USB 2.0 header (480 Mbps, for 2 USB ports)		

Continued on next column

Model	Alder Lake-N SKU	Twin Lake SKU	Amston Lake SKU
Power Connectors	<ul style="list-style-type: none"> <li>• 1 x 2-Pin DC-In 12V Power Connector</li> <li>• 1 x 2-Pin SATA 5V Power Connector</li> </ul>		
Fan Connectors	1 x 3-pin DC system fan connector		
System Connectors	<ul style="list-style-type: none"> <li>• 1 x Front panel header</li> <li>• 2 x LAN LED connector</li> <li>• 1 x Front audio header (Line-out &amp; Mic-in)</li> <li>• 1 x LVDS inverter header (5V/ 12V)</li> <li>• 1 x LVDS +eDP wafer connector</li> <li>• 1 x COM header <ul style="list-style-type: none"> <li>- 2 x COM (serial): Supports RS-232/ 422/ 485, with 0V/ 5V/ 12V (default 5V)</li> </ul> </li> <li>• 1 x GPIO header <ul style="list-style-type: none"> <li>- GPIO: 16-bit, 8 x GPI, 8 x GPO</li> </ul> </li> <li>• 1 x SMBus header</li> <li>• 1 x CMOS battery header</li> </ul>		
Jumpers	<ul style="list-style-type: none"> <li>• 1 x COM voltage select jumper</li> <li>• 1 x LVDS/ eDP power select jumper (3V/ 5V)</li> <li>• 1 x AT/ ATX mode select jumper</li> <li>• 1 x Clear CMOS jumper</li> <li>• 1 x ME jumper</li> </ul>		
OS Driver Support	<ul style="list-style-type: none"> <li>• Windows 10 IoT Enterprise 21H2 LTSC* (64-Bit)</li> <li>• Windows 11 IoT Enterprise 24H2 LTSC (64-Bit)</li> <li>• Linux (support by request)</li> </ul> <p>*Windows 10 IoT Enterprise only supports Alder Lake-N and Amston Lake processors.</p>		
Certification	CE, FCC Class B, BSMI, RCM, VCCI, UKCA, IC		
Environment	<ul style="list-style-type: none"> <li>• Operating Temperature: <b>-10 ~ 60°C</b></li> <li>- Thermal w/ Airflow: 0.7m/s</li> <li>- The standard thermal solution only supports TDP up to <b>12W</b>.</li> </ul>	<ul style="list-style-type: none"> <li>• Operating Temperature: <b>-10 ~ 60°C</b></li> <li>- Thermal w/ Airflow: 0.7m/s</li> <li>- The standard thermal solution only supports TDP up to <b>6W</b>.</li> </ul>	<ul style="list-style-type: none"> <li>• Operating Temperature: <b>-40 ~ 70°C</b></li> <li>- Thermal w/ Airflow: 0.7m/s</li> <li>- The standard thermal solution only supports TDP up to <b>9W</b>.</li> </ul>
	Storage Temperature: <b>-20 ~ 80°C</b>		Storage Temperature: <b>-40 ~ 80°C</b>
	<ul style="list-style-type: none"> <li>• Operating Humidity: 10 ~ 90%, non-condensing</li> <li>• Relative Humidity: 10 ~ 90%, non-condensing</li> </ul>		

# Motherboard Overview

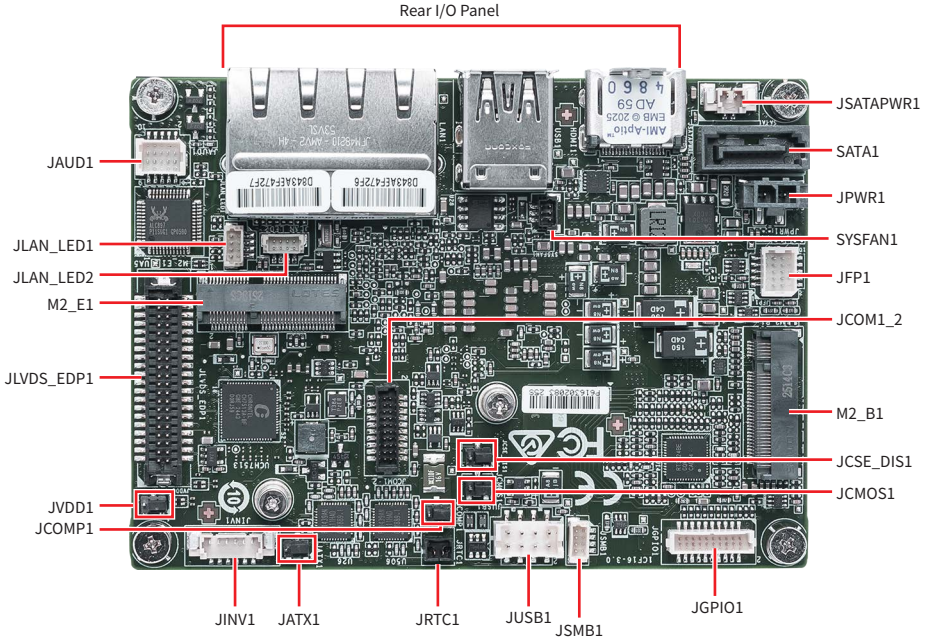

# Rear I/O Panel

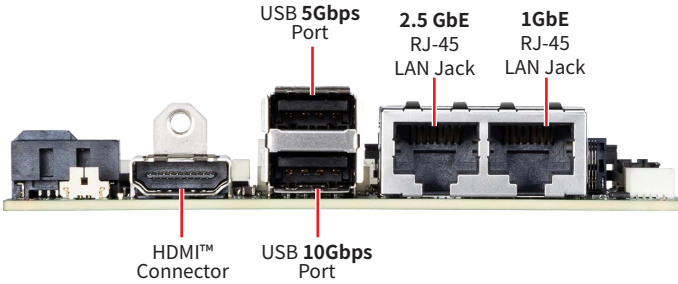

## HDMI™ Connector **HDMI™** HIGH-DEFINITION MULTIMEDIA INTERFACE

HDMI™ is an all-digital interface for uncompressed audio/video streams, supporting standard, enhanced, or high-definition video, and multi-channel digital audio on a single cable.

## USB 10Gbps Port

This connector delivers high-speed data transfer for various devices, such as storage devices, hard drives, video cameras, etc. It supports data transfer rates up to **10 Gbps**.

## USB 5 Gbps Port

The USB (Universal Serial Bus) port is for attaching USB devices such as keyboards, mouse, or other USB-compatible devices. It supports data transfer rates up to **5 Gbps**.

## GbE RJ-45 LAN Jack

The standard single RJ45 LAN jack is provided for connection to the Local Area Network (LAN). You can connect a network cable to it.

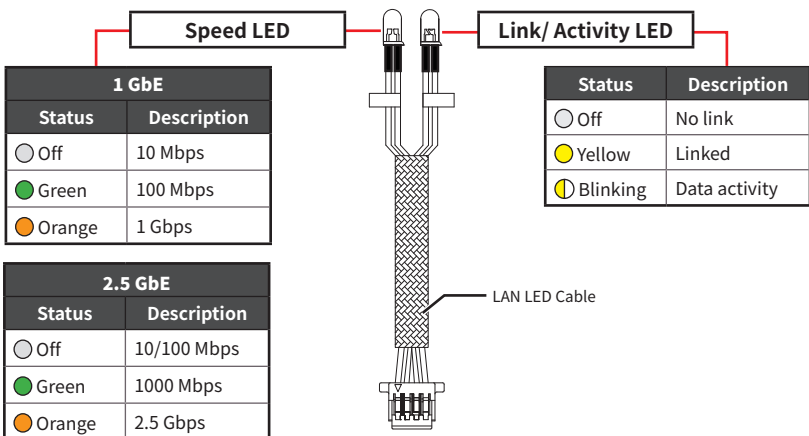

# ME Overview

## Board Dimension

Unit of measurement: mm

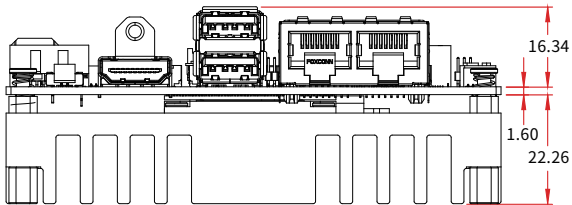
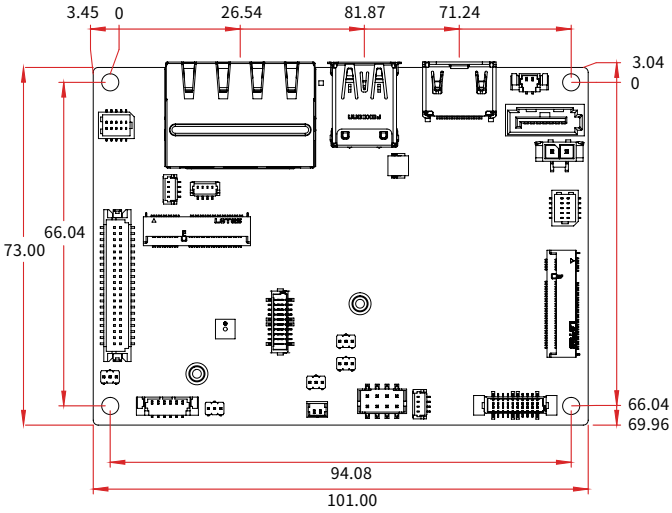

# Suggested Chassis I/O Gap Dimension

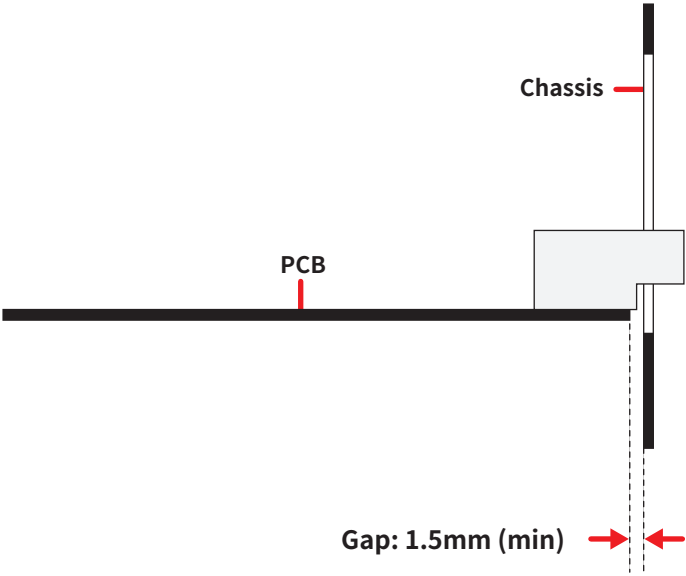

# Component Contents

Component	Page
<b>Storage</b>	<b>16</b>
SATA1: SATA 3.0 6Gb/s Port	16
<b>Expansion Slots</b>	<b>17</b>
M2_B1: M.2 Slot (B Key, 2242, 3042)	17
M2_E1: M.2 Slot (E Key, 2230)	18
<b>Connectors</b>	<b>19</b>
<b>Power Connectors</b>	<b>19</b>
JPWR1: 2-Pin DC-In 12V Power Connector	19
JSATAPWR1: 2-Pin SATA 5V Power Connector	19
<b>Cooling Connector</b>	<b>20</b>
SYSFAN1: System Fan Connector	20
<b>Audio Connector</b>	<b>21</b>
JAUD1: Front Audio Header	21
<b>Graphics Connectors</b>	<b>22</b>
JINV1: LVDS Inverter Header	22
JLVDS_EDP1: LVDS+eDP Wafer Connector	23
<b>USB Connector</b>	<b>25</b>
JUSB1: USB 2.0 Header	25
<b>Other Connectors</b>	<b>26</b>
JFP1: Front Panel Connector	26
LAN_LED1~2: LAN LED Connector	26
JSMB1: SMBus Header	26
JGPIO1: GPIO Connector	27
JCOM1_2: COM Connector	28
JRTC1: CMOS Battery Header	30
Replacing CMOS battery	30
<b>Jumpers</b>	<b>31</b>

# Storage

## SATA1: SATA 3.0 6Gb/s Port

This connector is SATA 6Gb/s interface port, it can connect to one SATA device.

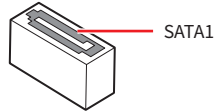
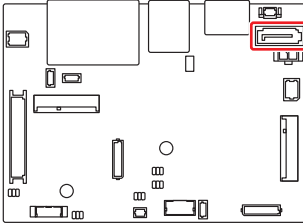

### **Important**

- This SATA port supports hot plug.
- Please do not fold the SATA cable at a 90-degree angle. Data loss may result during transmission otherwise.
- SATA cables have identical plugs on either sides of the cable. However, it is recommended that the flat connector be connected to the motherboard for space saving purposes.

# Expansion Slots

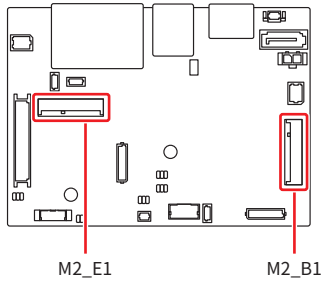

## M2\_B1: M.2 Slot (B Key, 2242, 3042)

Please install the WWAN Card/ solid-state drive (SSD) into the M.2 slot as shown below.

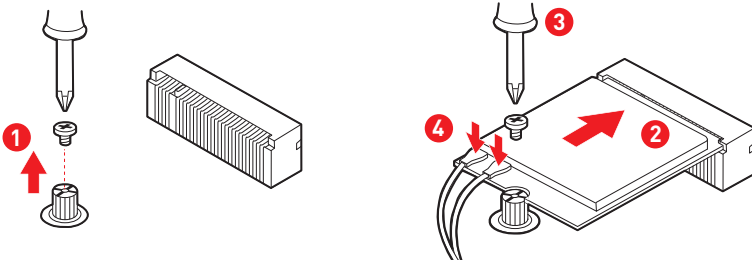

## Feature

- Supports SATA 3.0/ PCIe 3.0 x1, USB 10Gbps & USB 2.0 (480 Mbps) signals.
- Supports B+M key PCIe x1 module.
- Supports Quectel EM05-G Wi-Fi module with E-SIM.

## M2\_E1: M.2 Slot (E Key, 2230)

Please install the Wi-Fi/ Bluetooth card into the M.2 slot as shown below.

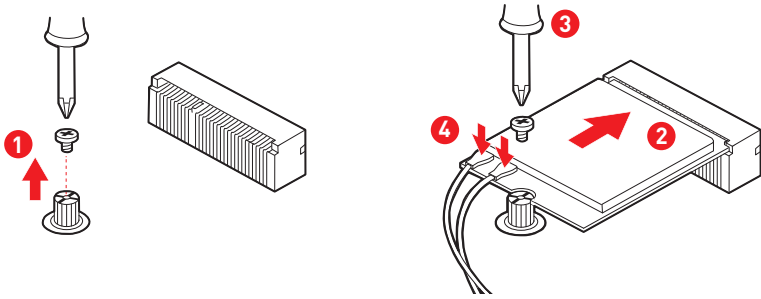

### Feature

- Supports PCIe 3.0 x1, USB 2.0 (480 Mbps) signal.
- Supports Intel® Wi-Fi 6E AX210 + BT 5.2 wireless card.
- Supports Intel® Wi-Fi 7 BE200 + BT 5.3 for Twin Lake.



### **Important**

*When adding or removing expansion cards, make sure that you unplug the power supply first. Meanwhile, read the documentation for the expansion card to configure any necessary hardware or software settings for the expansion card, such as jumpers, switches or BIOS configuration.*

# Connectors

## Power Connectors

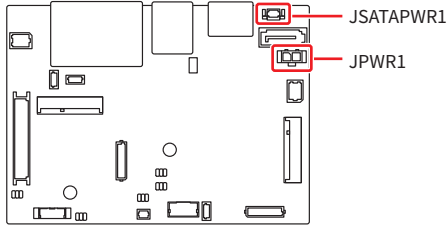

### JPWR1: 2-Pin DC-In 12V Power Connector

This connector allows you to connect a power supply.

JPWR1		1	DC-IN
		2	GND

### JSATAPWR1: 2-Pin SATA 5V Power Connector

This connector is used to provide power to SATA devices.

JSATAPWR1		1	VCC5
		2	GND

### **Important**

*Make sure that all the power cables are securely connected to a proper power supply to ensure stable operation of the system.*

# Cooling Connector

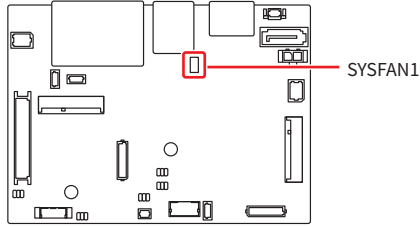

## SYSFAN1: System Fan Connector

The fan connector supports CPU/ system cooling fans with +12V. When connecting the wire to the connector, always note that the red wire is the positive and should be connected to the +12V; the black wire is Ground and should be connected to GND.

SYSFAN1		1	FAN SENSE
		2	+12V
		3	GND

### **Important**

Please refer to the recommended CPU fans at processor's official website or consult the vendors for proper CPU cooling fan.

# Audio Connector

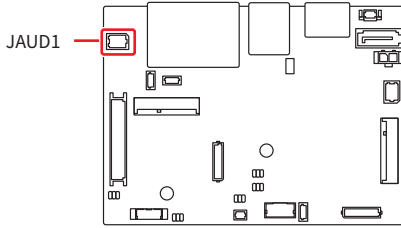

## JAUD1: Front Audio Header

This connector allows you to connect front panel audio.

<p>JAUD1</p>	1	LINE_OUT_R_F_J	2	MIC1_RA
	3	LINE_OUT_L_F_J	4	MIC1_LA
	5	FRONT_JD	6	MIC1_JD
	7	GND	8	GND
	9	NC	10	NC

# Graphics Connectors

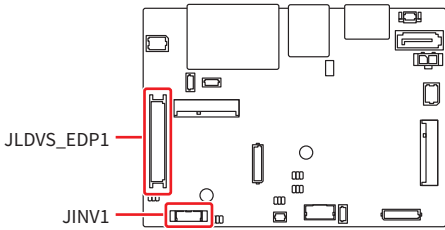

## JINV1: LVDS Inverter Header

The connector is provided for LCD backlight options.

	1	VCC5
	2	VCC12
	3	INV_ON
	4	L_BKLT_CTRL#
	5	GND
	6	GND

## JLVDS\_EDP1: LVDS+eDP Wafer Connector

This connector is intended for use with LVDS/eDP interface flat panels. When connecting your flat panel to this connector, please refer to the panel datasheet to ensure that you set the **JVDD1 (eDP/ LVDS power select jumper)** to the correct power voltage.

eDP Panel (P1)	CF16 Motherboard (P2)				eDP Panel (P1)
					
Lane3_P	EDP_LINE3_DP	1	2	EDP_LINE2_DP	Lane2_P
Lane3_N	EDP_LINE3_DN	3	4	EDP_LINE2_DN	Lane2_N
	DDC0_CLK	5	6	DDC0_DATA	
LCD_VCC	LCD_VDD	7	8	LCD_VDD	LCD_VCC
LCD_VCC	LCD_VDD	9	10	VCC3	
	BKLT_EN	11	12	LVDS_DETECT#	LCD_GND
Lane1_P	LVDSA_DATA1+	13	14	EHPDET/ LVDSA_DATA0+	HPD
Lane1_N	LVDSA_DATA1-	15	16	LVDSA_DATA0-	
H_GND	GND	17	18	GND	H_GND
	LVDSA_DATA3+	19	20	LVDSA_DATA2+	Lane0_P
	LVDSA_DATA3-	21	22	LVDSA_DATA2-	Lane0_N
H_GND	GND	23	24	GND	H_GND
	LVDSB_DATA1+	25	26	LVDSB_DATA0+	
	LVDSB_DATA1-	27	28	LVDSB_DATA0-	
H_GND	GND	29	30	GND	GND
	LVDSB_DATA3+	31	32	LVDSB_DATA2+	
	LVDSB_DATA3-	33	34	LVDSB_DATA2-	
	NA	35	36	GND	GND
	LVDSB_CLK+	37	38	LVDSA_CLK+	AUX_CH_P
	LVDSB_CLK-	39	40	LVDSA_CLK-	AUX_CH_N

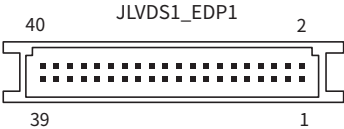
LVDS Panel (P1)	CF16 Motherboard (P2)				LVDS Panel (P1)
					
	EDP_LINE3_DP	1	2	EDP_LINE2_DP	
	EDP_LINE3_DN	3	4	EDP_LINE2_DN	
	DDC0_CLK	5	6	DDC0_DATA	
VCC	LCD_VDD	7	8	LCD_VDD	VCC
VCC	LCD_VDD	9	10	VCC3	
	BKLT_EN	11	12	LVDS_DETECT#	GND
RX01+	LVDSA_DATA1+	13	14	EHPDET/ LVDSA_DATA0+	RX00+
RX01-	LVDSA_DATA1-	15	16	LVDSA_DATA0-	RX00-
GND	GND	17	18	GND	GND
RX03+	LVDSA_DATA3+	19	20	LVDSA_DATA2+	RX02+
RX03-	LVDSA_DATA3-	21	22	LVDSA_DATA2-	RX02-
GND	GND	23	24	GND	GND
RXE1+	LVDSB_DATA1+	25	26	LVDSB_DATA0+	RXE0+
RXE1-	LVDSB_DATA1-	27	28	LVDSB_DATA0-	RXE0-
GND	GND	29	30	GND	GND
RXE3+	LVDSB_DATA3+	31	32	LVDSB_DATA2+	RXE2+
RXE3-	LVDSB_DATA3-	33	34	LVDSB_DATA2-	RXE2-
	NA	35	36	GND	GND
RXEC+	LVDSB_CLK+	37	38	LVDSA_CLK+	RXOC+
RXEC-	LVDSB_CLK-	39	40	LVDSA_CLK-	RXOC-

 **Important**

Pin 12 is a detect pin. When using a customized LVDS cable, pin 12 should be a signal ground with a low impedance. Otherwise, LVDS will not function.

# USB Connector

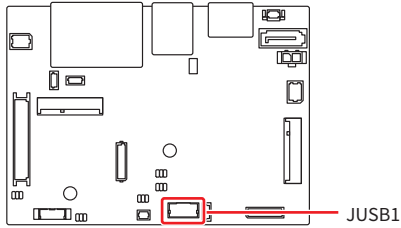

## JUSB1: USB 2.0 Header

This header is ideal for connecting USB devices such as keyboard, mouse, or other USB-compatible devices. It supports data transfer rate up to **480 Mbps**.

JUSB1		1	SVCC2	2	GND
		3	JUSB_4-	4	JUSB_3+
		5	JUSB_4+	6	JUSB_3-
		7	GND	8	SVCC2

## Other Connectors

### JFP1: Front Panel Connector

This front-panel connector is provided for electrical connection to the front panel switches & LEDs.

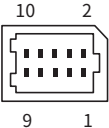
	1	HDD LED+	2	PLED
	3	HDD LED-	4	SLED
	5	GND	6	PWRBTIN#
	7	SYS_RESET-	8	GND
	9	NC	10	NC

### LAN\_LED1~2: LAN LED Connector

The LAN LED connector provides status indication for network connections via LEDs.

	1	LAN_LED_LINK#
	2	LAN_ACT_LINK
	3	LAN_LED_2500#
	4	LAN_LED_1000#

### JSMB1: SMBus Header

This header enables users to connect to the System Management Bus (SMBus) interface.

	1	5VSB
	2	SMBCLK
	3	SMBDATA
	4	GND

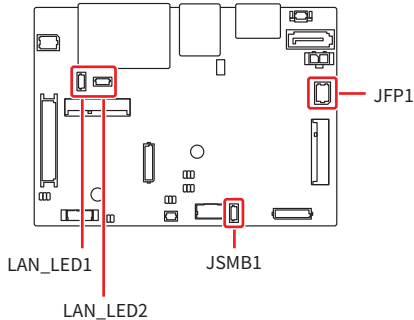

## JGPIO1: GPIO Connector

This connector is designed to provide General Purpose Input/Output (GPIO) signals. All GPI/ GPO can be flexibly selected by BIOS control.

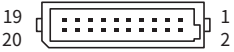
	1	GND	2	GND
	3	N_GPO0	4	N_GPI0
	5	N_GPO1	6	N_GPI1
	7	N_GPO2	8	N_GPI2
	9	N_GPO3	10	N_GPI3
	11	N_GPO4	12	N_GPI4
	13	N_GPO5	14	N_GPI5
	15	N_GPO6	16	N_GPI6
	17	N_GPO7	18	N_GPI7
	19	VCC5F	20	VCC5F

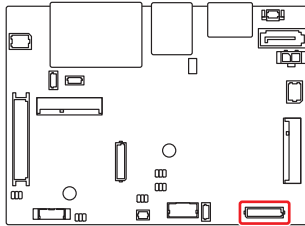

## JCOM1\_2: COM Connector

This connector is designed to provide serial communication capabilities.

	1	NDCD1#	2	NDCD2#
	3	NSIN1	4	NSIN2
	5	NSOUT1	6	NSOUT2
	7	NDTR1	8	NDTR2
	9	GND	10	GND
	11	NDSR1#	12	NDSR2#
	13	NRTS1	14	NRTS2
	15	NCTS1#	16	NCTS2#
	17	VCC_COM1	18	VCC_COM1
	19	NC	20	NC

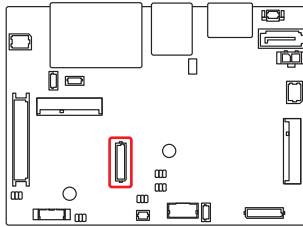

## Feature

- Supports RS-232/422/485, with 0V/5V/12V.
- RS- 232/ 422/ 485, selection by BIOS control.
- Supports True RS-232.
- Supports Auto flow control.
- Supports 1000m cable.



### **Important**

After connect COM header to printer, garbage can't be printed when power on/off.

RS232			
PIN		SIGNAL	DESCRIPTION
1	2	NDCD	Data Carrier Detect
3	4	NSIN	Signal In
5	6	NSOUT	Signal Out
7	8	NDTR	Data Terminal Ready
9	10	GND	Signal Ground
11	12	NDSR	Data Set Ready
13	14	NRTS	Request To Send
15	16	NCTS	Clear To Send
17	18	VCC_COM	VCC_COM

RS422			
PIN		SIGNAL	DESCRIPTION
1	2	422 TXD-	Transmit Data, Negative
3	4	422 TXD+	Transmit Data, Positive
5	6	422 RXD+	Receive Data, Positive
7	8	422 RXD-	Receive Data, Negative
9	10	GND	Signal Ground
11	12	NC	No Connection
13	14	NC	No Connection
15	16	NC	No Connection
17	18	NC	No Connection

RS485			
PIN		SIGNAL	DESCRIPTION
1	2	D-	Data, Negative
3	4	D+	Data, Positive
5	6	NC	No Connection
7	8	NC	No Connection
9	10	GND	Ground
11	12	NC	No Connection
13	14	NC	No Connection
15	16	NC	No Connection
17	18	NC	No Connection

## JRTC1: CMOS Battery Header

If the CMOS battery is out of charge, the time in the BIOS will be reset and the data of system configuration will be lost. In this case, you need to replace the CMOS battery.

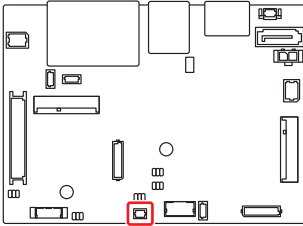

### Replacing CMOS battery

1. Unplug the battery wire from the JRTC1 connector and remove the battery.
2. Connect the new CR2032 battery with wire to the JRTC1 connector.

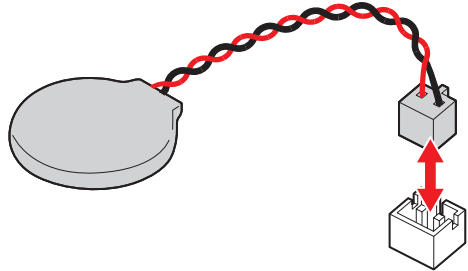

#### **WARNING**

#### **KEEP OUT OF REACH OF CHILDREN**

- Swallowing can lead to chemical burns, perforation of soft tissue, and even death.
- Severe burns can occur within 2 hours of ingestion.
- If you think batteries might have been swallowed or placed inside any part of the body, seek immediate medical attention.

# Jumpers



**Important**

Avoid adjusting jumpers when the system is on; it will damage the motherboard.

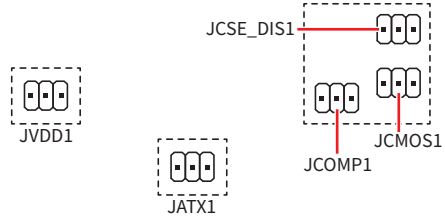
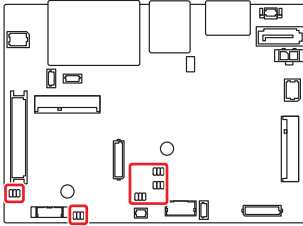

Jumper Name	Default Setting	Description
JCOMP1		<b>COM Power Select Jumper</b>
		1-2: 5V (Default) 2-3: 12V
JCMOS1		<b>Clear CMOS Jumper</b>
		1-2: Normal (Default) 2-3: Clear CMOS
JCSE_DIS1		<b>CSE Jumper</b>
		1-2: Normal (Default) 2-3: ME disable
JATX1		<b>AT/ ATX Mode Select Jumper</b>
		1-2: ATX (Default) 2-3: AT
JVDD1		<b>eDP/ LVDS Power Select Jumper</b>
		1-2: 3V (Default) 2-3: 5V

# BIOS Setup

This chapter provides information on the BIOS Setup program and allows users to configure the system for optimal use.

## Users may need to run the Setup program when:

- An error message appears on the screen at system startup and requests users to run SETUP.
- Users want to change the default settings for customized features.



### **Important**

- *Please note that BIOS update assumes technician-level experience.*
- *As the system BIOS is under continuous update for better system performance, the illustrations in this chapter should be held for reference only.*

## Entering Setup

Power on the computer and the system will start POST (Power On Self Test) process. When the message below appears on the screen, press <DEL> or <F2> key to enter Setup.

**Press <DEL> or <F2> to enter Setup.**

If the message disappears before you respond and you still wish to enter Setup, restart the system by turning it **OFF** and **ON** or pressing the **RESET** button. You may also restart the system by simultaneously pressing <Ctrl>, <Alt>, and <Delete> keys.



### **Important**

*The items under each BIOS category described in this chapter are under continuous update for better system performance. Therefore, the description may be slightly different from the latest BIOS and should be held for reference only.*

## Control Keys

← →	Select Screen
↑ ↓	Select Item
Enter	Select
+ -	Change Value
Esc	Exit
F1	General Help
F7	Previous Values
F8	Search setup items
F9	Optimized Defaults
F10	Save & Reset*
F12	Screenshot capture
<K>	Scroll help area upwards
<M>	Scroll help area downwards

\* When you press **F10**, a confirmation window appears and it provides the modification information. Select between **Yes** or **No** to confirm your choice.

## Getting Help

Upon entering setup, you will see the Main Menu.

### Main Menu

The main menu lists the setup functions you can make changes to. You can use the **arrow keys** ( ↑ ↓ ) to select the item. The on-line description of the highlighted setup function is displayed at the bottom of the screen.

### Sub-Menu

If you find a right pointer symbol appears to the left of certain fields that means a sub-menu can be launched from this field. A sub-menu contains additional options for a field parameter. You can use **arrow keys** ( ↑ ↓ ) to highlight the field and press **<Enter>** to call up the sub-menu. Then you can use the **control keys** to enter values and move from field to field within a sub-menu. If you want to return to the main menu, just press the **<Esc>**.

### General Help <F1>

The BIOS setup program provides a General Help screen. You can call up this screen from any menu by simply pressing **<F1>**. The Help screen lists the appropriate keys to use and the possible selections for the highlighted item. Press **<Esc>** to exit the Help screen.

# The Menu Bar

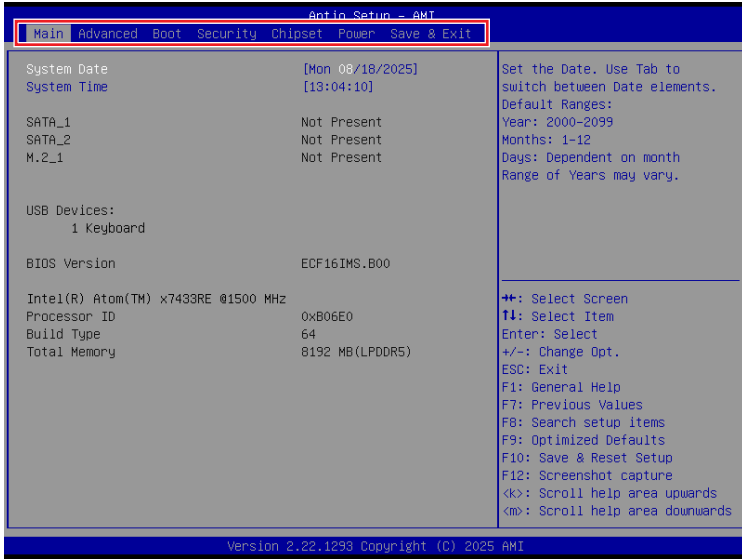

## ► Main

Use this menu for basic system configurations, such as time, date, etc.

## ► Advanced

Use this menu to set up the items of special enhanced features.

## ► Boot

Use this menu to specify the priority of boot devices.

## ► Security

Use this menu to set supervisor and user passwords.

## ► Chipset

This menu controls the advanced features of the onboard chipsets.

## ► Power

Use this menu to specify your settings for power management.

## ► Save & Exit

This menu allows you to load the BIOS default values or factory default settings into the BIOS and exit the BIOS setup utility with or without changes.

# Main

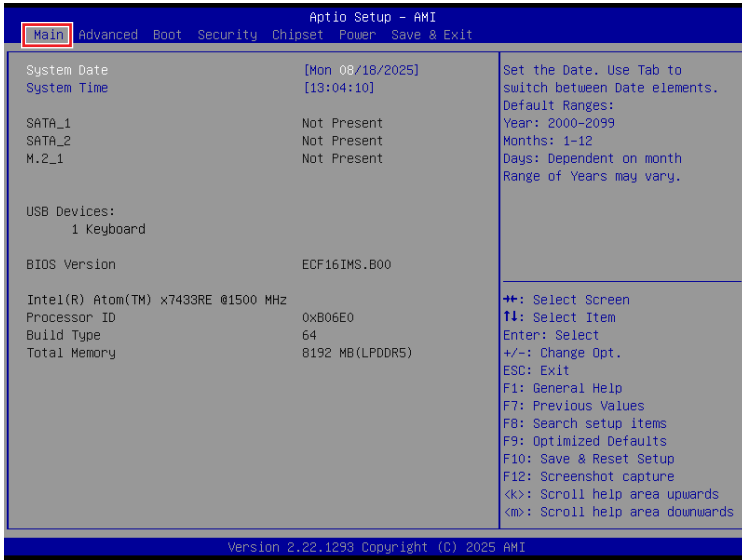

## ► System Date

This setting allows you to set the system date.

Format: <Day> <Month> <Date> <Year>.

## ► System Time

This setting allows you to set the system time.

Format: <Hour> <Minute> <Second>.

# Advanced

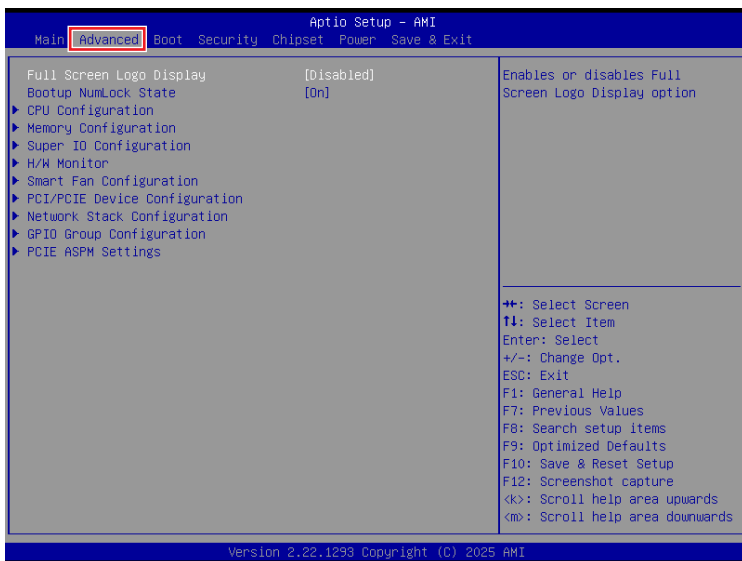

## ► Full Screen Logo Display

This BIOS feature determines if the BIOS should hide the normal POST messages with the motherboard or system manufacturer's full-screen logo.

[Enabled] BIOS will display the full-screen logo during the boot-up sequence, hiding normal POST messages.

[Disabled] BIOS will display the normal POST messages, instead of the full-screen logo.

Please note that enabling this BIOS feature often adds 2-3 seconds of delay to the booting sequence. This delay ensures that the logo is displayed for a sufficient amount of time. Therefore, it is recommended that you disable this BIOS feature for a faster boot-up time.

## ► Bootup NumLock State

This setting is to set the Num Lock status when the system is powered on.

[On] Turn on the Num Lock key when the system is powered on.

[Off] Allow users to use the arrow keys on the numeric keypad.

## ► CPU Configuration

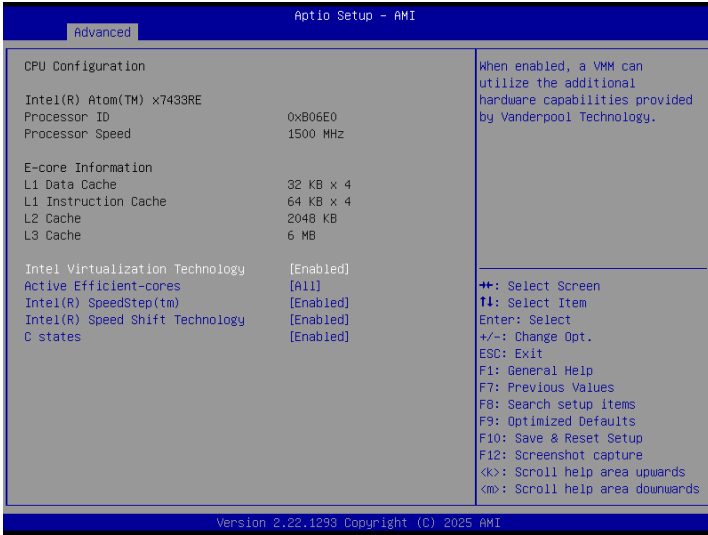

### ► Intel (VMX) Virtualization Technology

Virtualization enhanced by Intel Virtualization Technology will allow a platform to run multiple operating systems and applications in independent partitions. With Virtualization, one computer system can function as multiple “virtual” systems.

### ► Active Efficient-cores

Select the number of active Efficient-cores (E-cores).

### ► Intel(R) SpeedStep(tm)

EIST (Enhanced Intel SpeedStep Technology) allows the system to dynamically adjust processor voltage and core frequency, which can result in decreased average power consumption and decreased average heat production. When disabled, the processor will return the actual maximum CPUID (CPU Identification) input value of the processor when queried.

### ► Intel (R) Speed Shift Technology

Intel® Speed Shift Technology is an energy-efficient method that allows frequency control by hardware rather than the OS.

[Enabled] When enabled, Intel® Speed Shift Technology is activated. The technology enables the management of processor power consumption via hardware performance state (P-State) transitions.

[Disabled] Disable this function.

► **C States**

This setting controls the C-States (CPU Power states).

[Enabled]      Detects the idle state of system and reduce CPU power consumption accordingly.

[Disabled]     Disable this function.

## ► Memory Configuration



### ► In-Band ECC Support

Enables or disables In-Band ECC(Error-Correcting Code) Support.

[Enabled] When enabled this function, a portion(1/32) of memory space will be reserved to store ECC data.

[Disabled] Disables this function.

### ► In-Band ECC Error Operation Mode

Select an operation mode from 0-2. This feature only display when In-Band ECC Support is enabled.

### ► In-Band ECC Error Injection Control

Enables or disables In-Band ECC Error Injection. This feature only display when **In-Band ECC Support** is enabled.

## ► Super IO Configuration

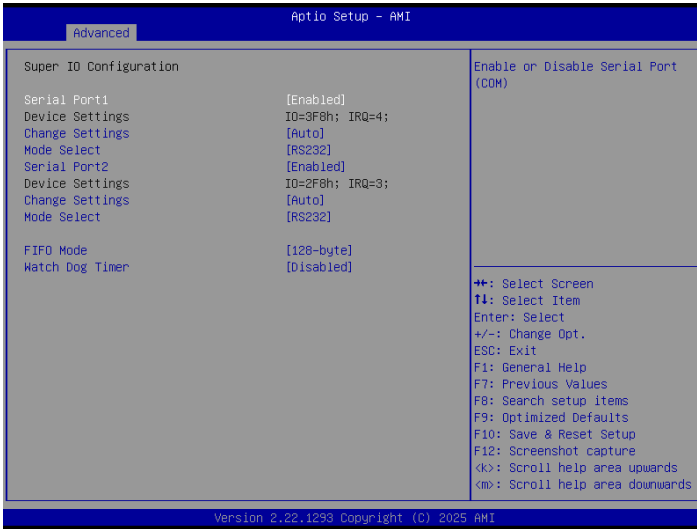

### ► Serial Port 1

This setting enables/ disables the specified serial port.

#### » Change Settings

This setting is used to change the address & IRQ settings of the specified serial port.

#### » Mode Select

Select an operation mode for Serial Port 1.

### ► FIFO Mode

This setting controls the FIFO data transfer mode.

### ► Watch Dog Timer

You can enable the system watchdog timer, a hardware timer that generates a reset when the software that it monitors does not respond as expected each time the watchdog polls it.

## ► H/W Monitor (PC Health Status)

These items display the current status of all monitored hardware devices/components such as voltages, temperatures and all fans' speeds.

Advanced		Aptio Setup - AMI	
Pc Health Status			
CPU temperature	:	+45 °C	
System temperature	:	+46 °C	
SYSFAN	:	N/A	
VCC_CORE	:	+0.816 V	
VCC3	:	+3.312 V	
VCC5	:	+5.045 V	
+12V	:	+12.144 V	
VSB3V	:	+3.312 V	
VSB5V	:	+4.968 V	
VBAT	:	+3.072 V	
			↔ : Select Screen

## ► Smart Fan Configuration

Advanced		Aptio Setup - AMI	
Configuration Smart FAN		Disabled/Enabled Smart FAN Function	
SYSFAN	[40 C]		
Min. Speed (%)	[50.0%]		

### ► SYSFAN

This setting enables/ disables the Smart Fan function. Smart Fan is an excellent feature which will adjust the System fan speed automatically depending on the current system temperature, avoiding the overheating to damage your system.

#### » Min. Speed (%)

The beginning speed of the System fan.

## ► PCI/ PCIE Device Configuration

Advanced		Aptio Setup - AMI	
Audio Controller	[Enabled]	Control Detection of the Audio Controller. Disabled = Audio Controller will be unconditionally disabled. Enabled = Audio Controller will be unconditionally Enabled.	

### ► Audio Controller

This setting enables/disables the onboard audio controller.

## ► Network Stack Configuration

This menu provides Network Stack settings for users to enable network boot (PXE) from BIOS.



### ► Network Stack

This menu provides Network Stack settings for users to enable network boot (PXE) from BIOS. The following items will display when **Network Stack** is enabled.

#### » **IPV4 PXE Support**

Enables or disables IPv4 PXE boot support.

#### » **IPV4 HTTP Support**

Enables or disables Ipv4 HTTP Support.

#### » **IPV6 PXE Support**

Enables or disables Ipv6 PXE Support.

#### » **IPV6 HTTP Support**

Enables or disables Ipv6 HTTP Support.

#### » **PXE boot wait time**

Use this option to specify the wait time to press the ESC key to abort the PXE boot. Press “+” or “-” on your keyboard to change the value. The default setting is 0.

#### » **Media detect count**

Use this option to specify the number of times media will be checked. Press “+” or “-” on your keyboard to change the value. The default setting is 1.

## ► GPIO Group Configuration



### ► GPIO0 ~ GPIO15

These settings control the operation mode of the specified GPIO.

## ► PCIE ASPM settings

This menu provide settings for PCIe ASPM (Active State Power Management) level for different installed devices.

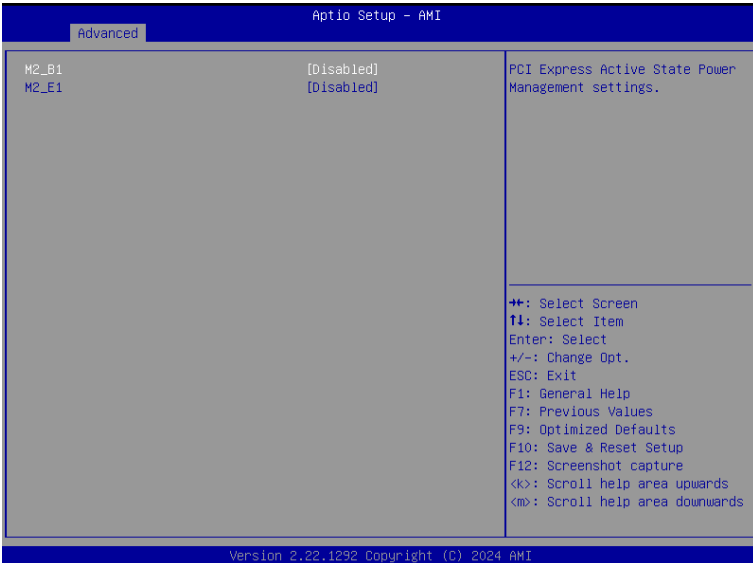

### ► M2\_B1/ M2\_E1

Sets PCI Express ASPM (Active State Power Management) state for power saving.

#### Lanes form PCH:

- [Disabled] Disable this function.
- [L1] Higher latency, lower power “standby” state.
- [Auto] Set the best state supported by the system.

#### Lanes form SA:

- [Disabled] Disable this function.
- [L1] Higher latency, lower power “standby” state.
- [L0sL1] Activate both L0s and L1 support.
- [L0s] Initiate an automatic shutdown of the system to protect from potential damage due to overheating.

# Boot

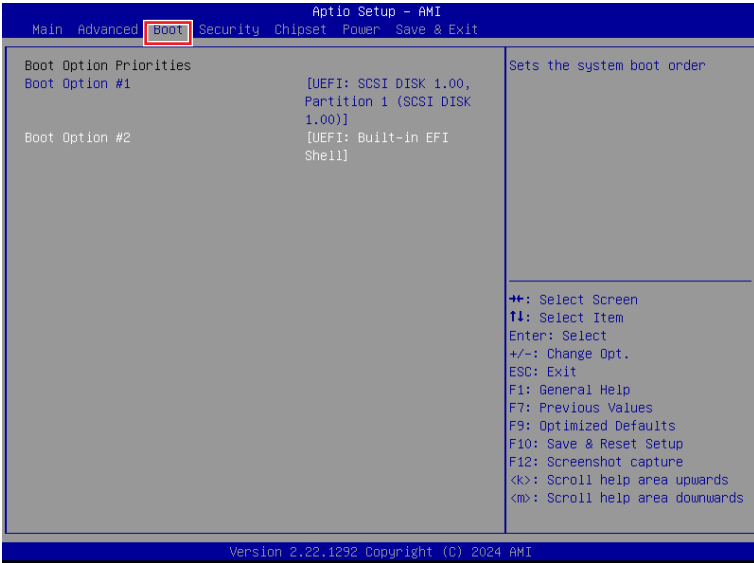

## ► Boot Option #1~2

This setting allows users to set the sequence of boot devices where BIOS attempts to load the disk operating system.

# Security

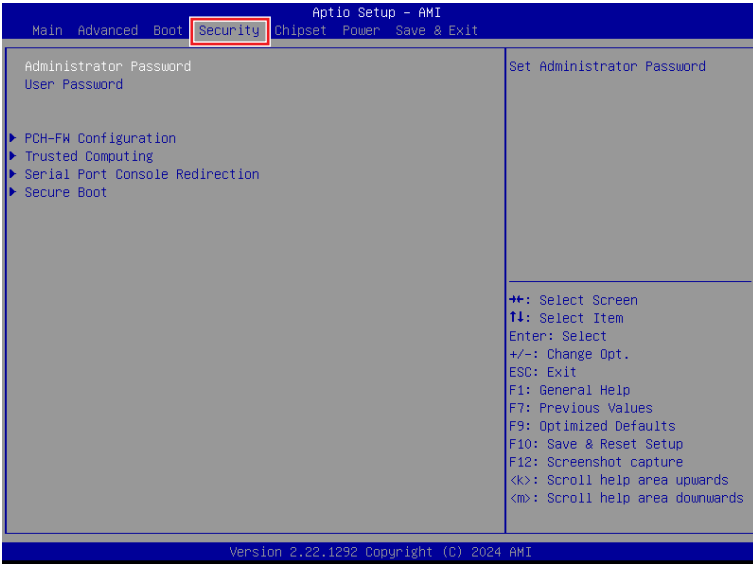

## ▶ Administrator Password

Administrator Password controls access to the BIOS Setup utility.

## ▶ User Password

User Password controls access to the system at boot and to the BIOS Setup utility.

## ▶ Disabled Block Sid

Enables or disables the Block SID authentication feature.

[Enabled] Allows SID authentication of TCG Storage device. This setting will only be applied on this boot.

[Disabled] Enables Block SID authentication.

## ► PCH-FW Configuration

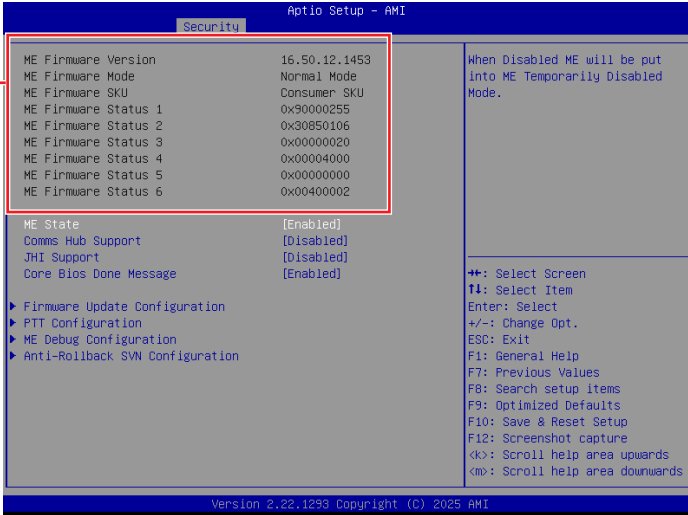

### Firmware Information

ME Firmware Version	System Integrity Value
ME Firmware Mode	ME Firmware Status 1~6
ME Firmware SKU	

These settings show the firmware information of the Intel ME (Management Engine).

#### ► ME State

This setting specifies the Intel Management Engine state.

#### ► Comms Hub Support

This setting enables/ disables Communications Hub Support.

#### ► JHI Support

This setting enables/disables support for Intel Dynamic Application Loader Host Interface (JHI).

#### ► Core BIOS Done Message

This setting enables/disables Core BIOS Done Message sent to ME.

► **Firmware Update Configuration**

Aptio Setup - AMI		
Security		
Me FW Image Re-Flash	[Disabled]	Enable/Disable Me FW Image Re-Flash function.
FW Update	[Enabled]	

» **ME FW Image Re-Flash**

This setting enables/ disables the ME FW (Firmware) image re-flash.

» **FW Update**

This setting enables/ disables the FW (Firmware) update.

► **PTT Configuration**

Intel Platform Trust Technology (PTT) is a platform functionality for credential storage and key management used by Microsoft Windows.

Aptio Setup - AMI		
Security		
PTT Capability / State	1 / 0	Selects TPM device: PTT or dTPM. PTT - Enables PTT in SkuMgr dTPM 1.2 - Disables PTT in SkuMgr Warning ! PTT/dTPM will be disabled and all data saved on it will be lost.
TPM Device Selection	[dTPM]	

» **TPM Device Selection**

Select TPM (Trusted Platform Module) devices from PTT or dTPM (Discrete TPM).

[PTT] Enables PTT in SkuMgr.

[dTPM] Disables PTT in SkuMgr. Warning! PTT/ Discrete TPM will be disabled and all data saved on it will be lost.

► **ME Debug Configuration**

Aptio Setup - AMI		
Security		
HECI Timeouts	[Enabled]	Enable/Disable HECI Send/Receive Timeouts.
Force ME DID Init Status	[Disabled]	
CPU Replaced Polling Disable	[Disabled]	
HECI Message check Disable	[Disabled]	
MBP HOB Skip	[Disabled]	
HECI2 Interface Communication	[Disabled]	
KT Device	[Enabled]	
End Of Post Message	[Send in DXE]	
DOI3 Setting for HECI Disable	[Disabled]	
MCTP Broadcast Cycle	[Disabled]	

» **HECI Timeouts**

This setting enables/ disables the HECI (Host Embedded Controller Interface) send/ receive timeouts.

» **Force ME DID Init Status**

Forces the DID initialization status value.

- » **CPU Replaced Polling Disable**  
Setting this option disables the CPU replacement polling loop.
- » **HECI Message Check Disable**  
This setting disables message check for BIOS boot path when sending messages.
- » **MBP HOB Skip**  
Setting this option will skip MBP HOB.
- » **HECI2 Interface Communication**  
This setting Adds/ Removes HECI2 device from PCI space.
- » **KT Device**  
This setting enables/ disables KT Device.
- » **End of Post Message**  
This setting enables/ disables End of Post Message sent to ME.
- » **DOI3 Setting for HECI Disable**  
Setting this option disables setting DOI3 bit for all HECI devices.
- » **MCTP Broadcast Cycle**  
This setting enables/ disables Management Component Transport Protocol (MCTP) Broadcast Cycle.

#### ► Anti-Rollback SVN Configuration

Security		Aptio Setup - AMI
Minimal Allowed Anti-Rollback SVN	0	When enabled, hardware-enforced Anti-Rollback mechanism is automatically activated: once ME FW was successfully run on a platform, FW with lower ARB-SVN will be blocked from execution
Executing Anti-Rollback SVN	1	
Automatic HW-Enforced Anti-Rollback SVN	[Disabled]	
Set HW-Enforced Anti-Rollback for Current SVN	[Disabled]	

- » **Automatic HW-Enforced Anti-Rollback SVN**  
Setting this option enables will automatically activate the hardware-enforced Anti-Rollback security version (HW ERB SVN). Once ME FW was successfully run on a platform, FW with lower ARB-VN will be blocked from execution.
- » **Set HW-Enforced Anti-Rollback for Current SVN**  
Enable HW ERB mechanism for current ARB SVN value. FW with lower ARB-SVN will be blocked from execution. The value will be restored to disable after the command is sent.

## ► Trusted Computing

Security		Aptio Setup - AMI
TPM 2.0 Device Found		Enables or Disables BIOS support for security device. O.S. will not show Security Device. TCG EFI protocol and INT1A interface will not be available.
Firmware Version:	15.23	
Vendor:	IFX	
Security Device Support	[Enable]	
Active PCR banks	SHA256	
Available PCR banks	SHA256,SHA384	
SHA256 PCR Bank	[Enabled]	
SHA384 PCR Bank	[Disabled]	
Pending operation	[None]	
Platform Hierarchy	[Enabled]	
Storage Hierarchy	[Enabled]	
Endorsement Hierarchy	[Enabled]	
Physical Presence Spec Version	[1.3]	
TPM 2.0 InterfaceType	[TIS]	
PH Randomization	[Enabled]	
Device Select	[TPM 2.0]	
		⇨: Select Screen T1: Select Item Enter: Select +/-: Change Opt. ESC: Exit F1: General Help F7: Previous Values F8: Search setup items F9: Optimized Defaults F10: Save & Reset Setup F12: Screenshot capture <>: Scroll help area upwards <M>: Scroll help area downwards

### ► Security Device Support

This item enables or disables BIOS support for security device. When set to [Disable], the OS will not show security device.

### ► SHA256/ SHA384 PCR Bank

These settings enable/disable the SHA256 PCR Bank and SHA384 PCR Bank.

### ► Pending Operation

When **Security Device Support** is set to [Enable], **Pending Operation** will appear. It is advised that users should routinely back up their TPM secured data.

[TPM Clear] Clear all data secured by TPM.

[None] Discard the selection.

### ► Platform Hierarchy, Storage Hierarchy, Endorsement Hierarchy

These settings enable/disable the Platform Hierarchy, Storage Hierarchy and Endorsement Hierarchy.

### ► Physical Presence Spec Version

This settings show the Physical Presence Spec Version.

### ► TPM 2.0 Interface Type

This setting shows the TPM 2.0 Interface Type.

### ► PH Randomization

This setting enables/disables PH Randomization.

### ► Device Select

Select your TPM device through this setting.

## ► Serial Port Console Redirection



### ► Console Redirection

Console Redirection operates in host systems that do not have a monitor and keyboard attached. This setting enables/disables the operation of console redirection. When set to [Enabled], BIOS redirects and sends all contents that should be displayed on the screen to the serial COM port for display on the terminal screen. Besides, all data received from the serial port is interpreted as keystrokes from a local keyboard.

► **Console Redirection Settings (COM1)**

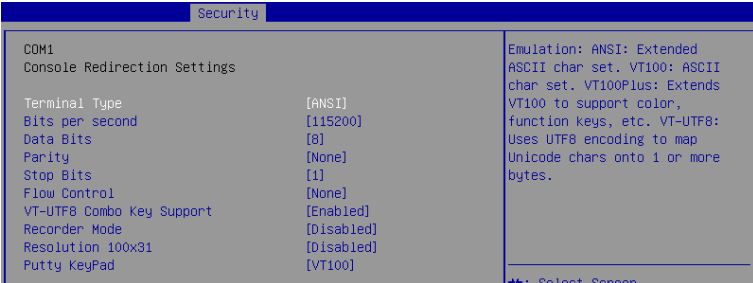

» **Terminal Type**

To operate the system’s console redirection, you need a terminal supporting ANSI terminal protocol and a RS-232 null modem cable connected between the host system and terminal(s). You can select emulation for the terminal from this setting.

- [ANSI] Extended ASCII character set.
- [VT100] ASCII character set.
- [VT100Plus] Extends VT100 to support color, function keys, etc.
- [VT-UTF8] Uses UTF8 encoding to map Unicode characters onto one or more bytes.

» **Bits per second, Data Bits, Parity, Stop Bits**

These setting specifies the transfer rate (bits per second, data bits, parity, stop bits) of Console Redirection.

» **Flow Control**

Flow control is the process of managing the rate of data transmission between two nodes. It’s the process of adjusting the flow of data from one device to another to ensure that the receiving device can handle all of the incoming data. This is particularly important where the sending device is capable of sending data much faster than the receiving device can receive it.

» **VT-UTF8 Combo Key Support**

This setting enables/disables the VT-UTF8 combination key support for ANSI/VT100 terminals.

» **Recorder Mode, Resolution 100x31**

These settings enable/disable the recorder mode and the resolution 100x31.

» **Putty Keypad**

PuTTY is a terminal emulator for Windows. This setting controls the numeric keypad for use in PuTTY.

## ► Secure Boot



### ► Secure Boot

Secure Boot function can be enabled only when the **Platform Key (PK)** is enrolled and running accordingly.

### ► Secure Boot Mode

Selects the secure boot mode. This item appears when **Secure Boot** is enabled.

[Standard] The system will automatically load the secure keys from BIOS.

[Custom] Allows user to configure the secure boot settings and manually load the secure keys.

### ► Restore Factory Keys

Allows you to restore all factory default keys. The settings will be applied after reboot or at the next reboot. This item appears when "**Secure Boot Mode**" sets to [Custom].

### ► Reset to setup Mode

Allows you to delete all the Secure Boot keys (PK, KEK, db, dbt, dbx). The settings will be applied after reboot or at the next reboot. This item appears when "**Secure Boot Mode**" sets to [Custom].

### ► Key Management

Press **Enter** key to enter the sub-menu. Manage the secure boot keys. This item appears when "**Secure Boot Mode**" sets to [Custom].

# Chipset

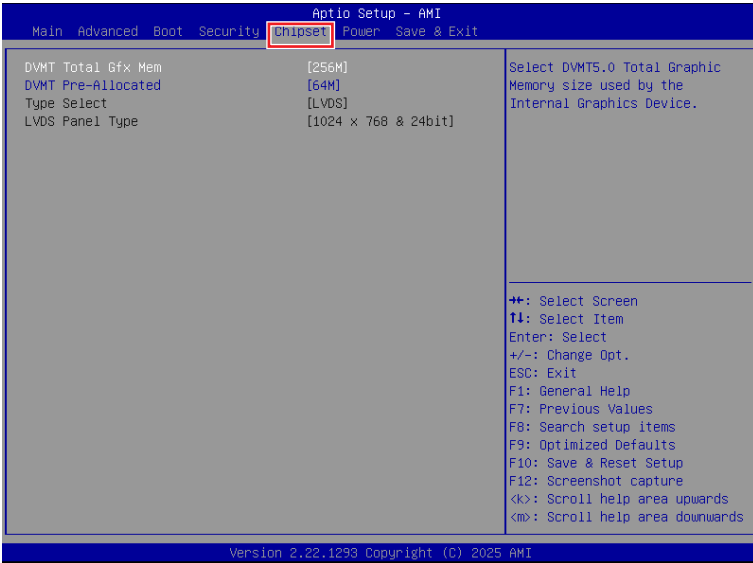

## ► DVMT Total Gfx Mem

This setting specifies the memory size for DVMT.

## ► DVMT Pre-Allocated

This setting defines the DVMT pre-allocated memory. Pre-allocated memory is the small amount of system memory made available at boot time by the system BIOS for video. Pre-allocated memory is also known as locked memory. This is because it is “locked” for video use only and as such, is invisible and unable to be used by the operating system.

### ► Type Select

Set your video signal interface as LVDS or eDP.

#### » LVDS Panel Type

This setting specifies the LCD Panel’s resolution and distribution formats. The item will display when **Panel 1 Type is set to LVDS**.

# Power

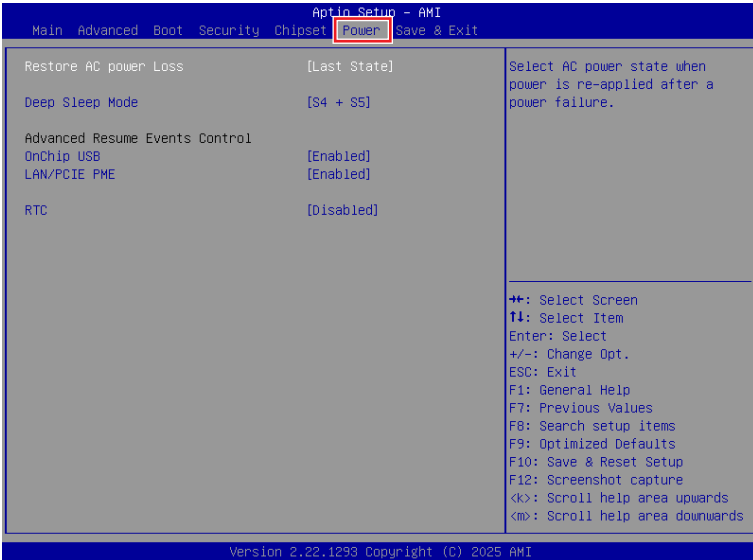

## ▶ Restore AC Power Loss

This setting specifies whether your system will reboot after a power failure or interrupt occurs. Available settings are:

- [Power Off] Leaves the computer in the power off state.
- [Power On] Leaves the computer in the power on state.
- [Last State] Restores the system to the previous status before power failure or interrupt occurred.

## ▶ Deep Sleep Mode

The setting enables/disables the S4 + S5 power saving mode.

## ▶ OnChip USB

The item allows the activity of the OnChip USB device to wake up the system from S4/ S5 sleep state.

## ▶ LAN/ PCIE PME

Enables or disables the system to be awakened from the power saving modes when activity or input signal of Intel LAN device and onboard PCIE PME is detected.

## ▶ RTC

When [Enabled], you can set the date and time at which the RTC (real-time clock) alarm awakens the system from suspend mode.

# Save & Exit

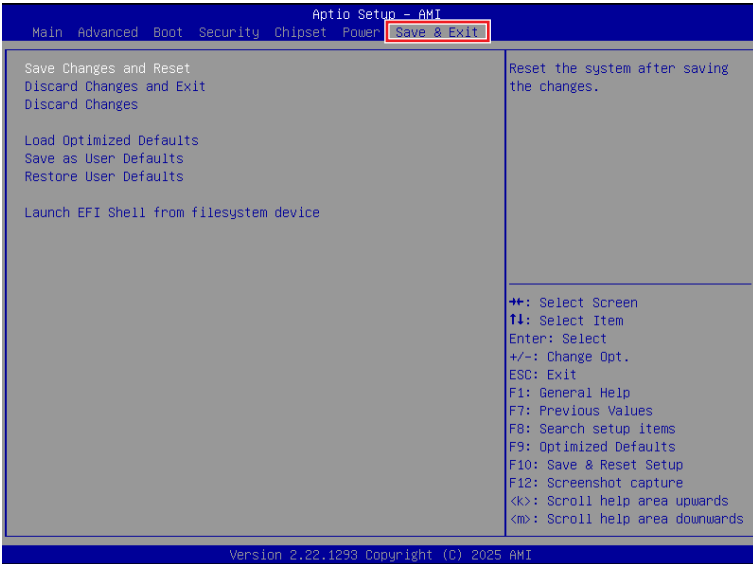

## ► Save Changes and Reset

Save changes to CMOS and reset the system.

## ► Discard Changes and Exit

Abandon all changes and exit the Setup Utility.

## ► Discard Changes

Abandon all changes.

## ► Load Optimized Defaults

Use this menu to load the default values set by the motherboard manufacturer specifically for optimal performance of the motherboard.

## ► Save as User Defaults

Save changes as the user's default profile.

## ► Restore User Defaults

Restore the user's default profile.

## ► Launch EFI Shell from filesystem device

This setting helps to launch the EFI Shell application from one of the available file system devices.

# Audio Driver Setup

## Installing the Intel® SST Audio Driver

The **Intel® Smart Sound Technology (Intel® SST) driver** enables high-quality audio processing, voice interactions, and microphone functionality on your device. This section guides you through installing the Intel® SST driver and the associated audio codec driver on a Windows operating system.



To enable the **Realtek audio codec** to function under the Intel® Smart Sound Technology (Intel® SST) framework on your PC, the Intel® SST driver **must be installed** before the Realtek audio driver.

### Prerequisites

- **Operating System:** Windows 10 or Windows 11 (64-bit).
- **Administrative Privileges:** Administrator access to the PC.
- **Internet Connection:** Required for driver downloads.

## Key Reminder

Install the Intel® SST driver before the Realtek audio driver. The Intel® SST driver provides the necessary framework to prevent errors.

## Installation Steps

1. **Download** the Intel® SST Driver:
  - Visit the MSI Support Page for your IPC model.
  - Download the Intel® SST driver (.zip) and save it to a known location.
2. **Locate and Extract** the Driver File:
  - Right-click and select **Extract All** to a folder.
3. **Sort and Identify** the .inf File:
  - Open the extracted folder and sort contents by **Type** to group .inf files.
  - Locate the Intel® SST **.inf file**.
4. **Install** the Driver:
  - Right-click all the .inf file and select Install.
  - If prompted by User Account Control (UAC) window, click “**Yes**” to allow changes.
  - On Windows 10, click “**OK**” when “The operation completed successfully” appears.
5. **Restart** your PC to apply the driver.
6. **Verify** Intel® SST Installation:
  - Open **Device Manager** (Windows + X > Device Manager).
  - Expand **Sound, Video, and Game Controllers** and confirm that Intel® Smart Sound Technology (Intel® SST) Audio Controller is listed without a yellow exclamation mark.

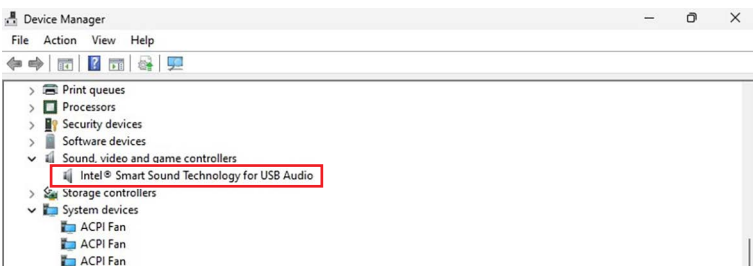

- **Note:** After completing Intel® SST installation, the “**Intel High Definition Audio**” item will be shown at “Other devices” of Device Manager. Please install the audio codec driver for this.

# GPIO WDT Programming

This chapter provides GPIO (General Purpose Input/ Output) and WDT (Watch Dog Timer) programming guide.

## Abstract

In this section, code examples based on C programming language provided for customer interest. **Inportb**, **Outportb**, **Inportl** and **Outportl** are basic functions used for access IO ports and defined as following.

**Inportb:** Read a single 8-bit I/O port.

**Outportb:** Write a single byte to an 8-bit port.

**Inportl:** Reads a single 32-bit I/O port.

**Outportl:** Write a single long to a 32-bit port.

# 1. General Purpose IO - GPIO / DIO

The GPIO port configuration addresses are listed in the following table:

Name	Output Enable	Output Value	Input Value	Bit
GPIO0	0xB0	0xB1	0xB2	0
GPIO1	0xB0	0xB1	0xB2	1
GPIO2	0xB0	0xB1	0xB2	2
GPIO3	0xB0	0xB1	0xB2	3
GPIO4	0xB0	0xB1	0xB2	4
GPIO5	0xB0	0xB1	0xB2	5
GPIO6	0xB0	0xB1	0xB2	6
GPIO7	0xB0	0xB1	0xB2	7
GPIO8	0xC0	0xC1	0xC2	0
GPIO9	0xC0	0xC1	0xC2	1
GPIO10	0xC0	0xC1	0xC2	2
GPIO11	0xC0	0xC1	0xC2	3
GPIO12	0xC0	0xC1	0xC2	4
GPIO13	0xC0	0xC1	0xC2	5
GPIO14	0xC0	0xC1	0xC2	6
GPIO15	0xC0	0xC1	0xC2	7

**Note:** GPIO control is done via port 0xA00 (index) and 0xA01 (data) for register access. Changes to output value registers are only applied when the GPIO is in output mode.

## 1.1 Set GPIO Mode (Input or Output):

1. Read the current value from the Output Enable register.
2. Modify the corresponding bit:
  - ✓ Set the bit to 1 for Output mode.
  - ✓ Clear the bit to 0 for Input mode.
3. Write the updated value back to the Output Enable register.

**Example:** Set **GPIO3** to Input mode

```
Outputb (0xA00, 0xB0); // Select GPIO3 Output Enable Register (0xB0)
val = Inportb (0xA01); // Read current value from the register
val = val & (~1 << 3); // Clear bit 3 (GPIO3) to 0 (Input mode)
Outputb (0xA01, val); // Write the updated value back to the register.
```

**Example:** Set **GPIO7** to Output mode

```
Outputb (0xA00, 0xB0); // Select GPIO7 Output Enable Register (0xB0)
val = Inportb (0xA01); // Read current value from the register
val = val | (1 << 7); // Set bit 7 (GPIO7) to 1 (Output mode)
Outputb (0xA01, val); // Write the updated value back to the register
```

## 1.2 Set output value of GPIO:

1. Read the current value from the Output value register.
2. Modify the corresponding bit.
  - ✓ Write 1 for logic High.
  - ✓ Write 0 for logic Low.
3. Write the updated value back to the Output value register.

**Example:** Set **GPIO2** output “high”

```
Outputb (0xA00, 0xB1); // Select GPIO2 Output value Register (0xB1)
val = Inportb (0xA01); // Read current value from the register
val = val | (1<<2); // Set bit 2 (GPIO2) to 1 (output “high”)
Outputb (0xA01, val); // Write the updated value back to the register
```

**Example:** Set **GPIO6** output “low”

```
Outputb (0xA00, 0xB1); // Select GPIO6 Output value Register (0xB1)
val = Inportb (0xA01); // Read current value from the register
val = val & (~1<<6); // Clear bit 6 (GPIO6) to 0 (output “low”)
Outputb (0xA01, val); // Write the updated value back to the register
```

## 1.3 Read input value from GPIO:

1. Read the register value.
2. Mask the corresponding bit to get the pin state:
  - ✓ Bit = 1 : Input is High
  - ✓ Bit = 0 : Input is Low

**Example:** Get **GPIO1** input value.

```
Outputb (0xA00, 0xB2); // Select GPIO1 Input value Register (0xB2)
val = Inportb (0xA01); // Read current value from the register
val = val & (1<<1); // Read GPIO1 (bit 1).
if (val) printf (“Input of GPIO1 is High”);
else printf (“Input of GPIO1 is Low”);
```

## 2. Watchdog Timer - WDT

The base address (WDT\_BASE) of WDT configuration registers is **0xA10**.

### 2.1 Set WDT Time Unit

```
val = Inportb (WDT_BASE + 0x05); // Read current WDT setting
val = val | 0x08; // minute mode. val = val & 0xF7 if second mode
Outportb (WDT_BASE + 0x05, val); // Write back WDT setting
```

### 2.2 Set WDT Time

```
Outportb (WDT_BASE + 0x06, Time); // Write WDT time, value 1 to 255.
```

### 2.3 Enable WDT

```
val = Inportb (WDT_BASE + 0x0A); // Read current WDT_PME setting
val = val | 0x01; // Enable WDT OUT: WDOUT_EN (bit 0) set to 1.
Outportb (WDT_BASE + 0x0A, val); // Write back WDT setting.
val = Inportb (WDT_BASE + 0x05); // Read current WDT setting
val = val | 0x20; // Enable WDT by set WD_EN (bit 5) to 1.
Outportb (WDT_BASE + 0x05, val); // Write back WDT setting.
```

### 2.4 Disable WDT

```
val = Inportb (WDT_BASE + 0x05); // Read current WDT setting
val = val & 0xDF; // Disable WDT by set WD_EN (bit 5) to 0.
Outportb (WDT_BASE + 0x05, val); // Write back WDT setting.
```

### 2.5 Check WDT Reset Flag

If the system has been reset by WDT function, this flag will set to 1.

```
val = Inportb (WDT_BASE + 0x05); // Read current WDT setting.
val = val & 0x40; // Check WDTMOUT_STS (bit 6).
if (val) printf ("timeout event occurred");
else printf ("timeout event not occurred");
```

### 2.6 Clear WDT Reset Flag

```
val = Inportb (WDT_BASE + 0x05); // Read current WDT setting
val = val | 0x40; // Set 1 to WDTMOUT_STS (bit 6);
Outportb (WDT_BASE + 0x05, val); // Write back WDT setting
```