

QM-G700A

Industrial Embedded System
Quick Start Guide

Copyright Notice

This document is copyrighted, 2026. All rights are reserved. The original manufacturer reserves the right to make improvements to the products described in this manual at any time without notice.

No part of this manual may be reproduced, copied, translated, or transmitted in any form or by any means without the prior written permission of the original manufacturer. Information provided in this manual is intended to be accurate and reliable. However, the original manufacturer assumes no responsibility for its use, or for any infringements upon the rights of third parties that may result from its use.

The material in this document is for product information only and is subject to change without notice. While reasonable efforts have been made in the preparation of this document to assure its accuracy, Beijer assumes no liabilities resulting from errors or omissions in this document, or from the use of the information contained herein.

GIGAIPC reserves the right to make changes in the product design without notice to its users.

Acknowledgement

All other products' name or trademarks are properties of their respective owners.

- Microsoft Windows is a registered trademark of Microsoft Corp.
- ITE is a trademark of Integrated Technology Express, Inc.
- IBM, PC/AT, PS/2, and VGA are trademarks of International Business Machines Corporation.
- Arm® and Cortex® are registered trademarks of Arm Limited (or its subsidiaries)
- Yocto Project® is a trademark of The Linux Foundation.

All other product names or trademarks are properties of their respective owners.

Packing List

Before setting up your product, please make sure the following items have been shipped:

Item	Quantity
System	1
Power Cord : Optional (by region)	1
PSU ADP 19V 65W 100-240VAC (25EP0-1065W1-A3S)	1
Wall mount bracket (25HBA-G70020-U2R)	2

If any of these items are missing or damaged, please contact your distributor or sales representative immediately.

About this Document

This User's Manual contains all the essential information, such as detailed descriptions and explanations on the product's hardware and software features (if any), its specifications, dimensions, jumper/connector settings/definitions, and driver installation instructions (if any), to facilitate users in setting up their product.

Safety Precautions

Please read the following safety instructions carefully. It is advised that you keep this manual for future references

1. All cautions and warnings on the device should be noted.
2. Make sure the power source matches the power rating of the device.
3. Position the power cord so that people cannot step on it. Do not place anything over the power cord.
4. Always completely disconnect the power before working on the system's hardware.
5. No connections should be made when the system is powered as a sudden rush of power may damage sensitive electronic components.
6. If the device is not to be used for a long time, disconnect it from the power supply to avoid damage by transient over-voltage.
7. Always disconnect this device from any AC supply before cleaning.
8. While cleaning, use a damp cloth instead of liquid or spray detergents.
9. Make sure the device is installed near a power outlet and is easily accessible.
10. Keep this device away from humidity.
11. Place the device on a solid surface during installation to prevent falls
12. Do not cover the openings on the device to ensure optimal heat dissipation.

13. Watch out for high temperatures when the system is running.
14. Do not touch the heat sink or heat spreader when the system is running
15. Never pour any liquid into the openings. This could cause fire or electric shock.
16. As most electronic components are sensitive to static electrical charge, be sure to ground yourself to prevent static charge when installing the internal components. Use a grounding wrist strap and contain all electronic components in any static-shielded containers.
17. If any of the following situations arises, please the contact our service personnel:
 - i. Damaged power cord or plug
 - ii. Liquid intrusion to the device
 - iii. Exposure to moisture
 - iv. Device is not working as expected or in a manner as described in this manual
 - v. The device is dropped or damaged
 - vi. Any obvious signs of damage displayed on the device
18. **DO NOT LEAVE THIS DEVICE IN AN UNCONTROLLED ENVIRONMENT WITH TEMPERATURES BEYOND THE DEVICE'S PERMITTED STORAGE TEMPERATURES (SEE CHAPTER 1) TO PREVENT DAMAGE.**

FCC Statement

Warning!



This device complies with Part 15 FCC Rules. Operation is subject to the following two conditions: (1) this device may not cause harmful interference, and (2) this device must accept any interference received including interference that may cause undesired operation.

Caution:

There is a danger of explosion if the battery is incorrectly replaced. Replace only with the same or equivalent type recommended by the manufacturer. Dispose of used batteries according to the manufacturer's instructions and your local government's recycling or disposal directives.

Attention:

Il y a un risque d'explosion si la batterie est remplacée de façon incorrecte. Ne la remplacer qu'avec le même modèle ou équivalent recommandé par le constructeur. Recycler les batteries usées en accord avec les instructions du fabricant et les directives gouvernementales de recyclage.

High Temperature Warning

(1) This equipment is intended to be used in Restrict Access Location. The access can only be gained by Skilled person or by Instructed person who have been instructed about the metal chassis of the equipment is so hot that Skilled person have to pay special attention or take special protection.

Only authorized by well trained professional person can access the restrict access location.

(2) External metal parts are hot!! Before touching it, special attention or protection is necessary



Table Contents

Industrial Embedded System	1
Quick Start Guide	1
Copyright Notice	2
Acknowledgement	3
Packing List.....	4
About this Document.....	5
Safety Precautions	6
FCC Statement.....	8
High Temperature Warning	8
Chapter 1 - Product Specifications	13
1.1 Specifications	15
Chapter 2 – QM-G700A	17
2.1 Dimension	18
2.2 Getting Familiar with Your Unit.....	19
2.3 A) 5G module Installation: How to safely install the module (5G Module inclusion may vary based on local distribution).....	21
2.4 B) Wireless Module : How to safely install the Module (Wireless Module inclusion may vary based on local distribution)	22
2.5 Antenna Installation (Antenna inclusion may vary based	

	on local distribution)	23
2.6	Wall mount Bracket Installation.....	24
2.7	Cable Pin-define	25
2.8	Support	26
2.9	Safety and Regulatory Information.....	27

Chapter 3 – Hardware Information 28

3.1	Jumpers and Connectors	29
3.2.1	DC_IN4 (DC IN connector)	31
3.2.2	USB3C (USB Type C connector).....	32
3.2.3	HDMI (HDMI connector)	33
3.2.4	USB3 (USB 3.0 connector).....	34
3.2.5	LAN (LAN connector).....	35
3.2.6	HP (Combo audio jack (Headphone & Headset)).....	36
3.2.7	SPK_OUT (Speaker out connector)	37
3.2.8	FUSB (USB 2.0 headers).....	38
3.2.9	SYS_PANEL (Front panel header)	39
3.2.10	GPIO_CNT (General Purpose input/output header)	40
3.2.11	UART (UART connector)	41
3.2.12	M2E (M.2 Slot, 2230 E-key, Secure digital input/output interface (SDIO))	42
3.2.13	MIPI (Mobile Industry Processor Interface).....	43
3.2.14	BAT (Battery cable connector).....	44
3.2.15	MIPI_CON (MIPI touch connector)	45
3.2.16	M2B (M.2 Slot, 3052 B-key)	46
3.2.17	EDP_PWR (eDP power header)	47

3.2.18	EDP (eDP connector).....	48
3.2.19	SPI (OTG select jumper)	49
3.2.20	SIM_CARD (Nano SIM card slot)	50
3.2.21	SD (Micro SD card slot)	51

Chapter 1

Chapter 1 - Product Specifications

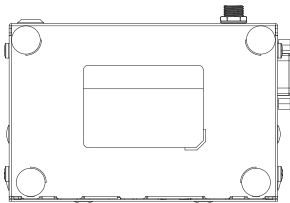
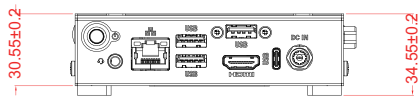
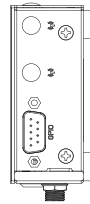
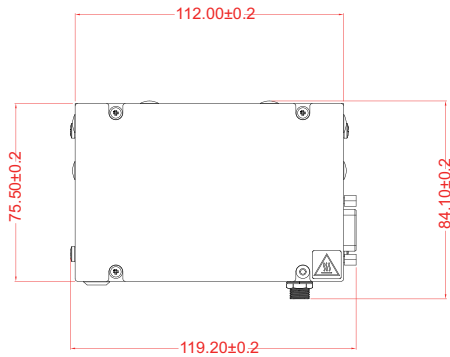
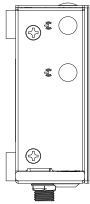
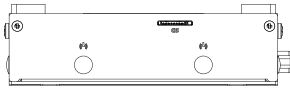

1.1 Specifications

System	QM-G700A (QM-G700A-SI)
Dimension	System Size : 112W x 75.5D x 30.55H (mm)
CPU	MediaTek Genio 700 (MT8390) 2 x Arm Cortex-A78, 2.2GHz 6 x Arm Cortex-A55, 2.0GHz
AI Inference Computing Power	MediaTek 5th-Gen NPU 4.0 TOPS (1x MDLA3.0 + 1x Tensilica VP6)
Memory	Onboard 8GB LPDDR4x
Ethernet	Realtek® RTL8211F-CG (10/100/1000 Mbps)
Graphic support	Arm Mali-G57 MC3 GPU, Support OpenGL ES 1.1/2.0/3.2, and Vulkan 1.0/1.1 : 1 x HDMI 2.0, supporting a maximum resolution of 4096x2160 @60Hz (Android only 1920x1200 @60Hz)
Audio	MT6365 (Integrated)
Storage	eMMC v5.1 64GB (on board)
Expansion Slots	1 x 2230 M.2 E-key slot (PCIe x1, USB2.0), supports WiFi6 : Azurewave AW-XB468NF (IC:MT7921L) 1 x 3052 M.2 B-Key slot (USB3.0), supports 5G : QUECTEL RM500K-CN / RM520N-GL
Front I/O	1 x Micro SD Slot 2 x External Antenna Holes (Optional)
Rear I/O	1 x Power button with LED 1 x Combo audio jack (Headphone & Headset) 1 x RJ45 LAN Port 2 x USB 3.0 Ports (Host) 1 x USB 2.0 Port 1 x USB Type C (OTG) 1 x HDMI 1 x Screw Type DC Jack
Side I/O	1 x GPIO (8 bits) 4 x External Antenna Holes (Optional)
Power	+12~24VDC (Adapter 19V/65W)

System	QM-G700A (QM-G700A-SI)
OS Compatibility	Yocto 24.1 Ubuntu 22.04 Android 13 (by demand)
Operation temperature	Operating temperature: -20°C to 60°C Operating humidity: 40°C @ 20-95% (non-condensing) Non-operating temperature: -40°C to 85°C Non-operating humidity: 60°C @ 95% (non-condensing) Use wide temperature range memory and storage
Vibration During Operation	Operation: IEC 60068-2-64, 3 Grms, random, 5 ~ 500 Hz, 1 hr / Per Axis, With SSD/M.2 2280 Non-operation: IEC 60068-2-6, 2 Grms, Sine, 10 ~ 500 Hz, 1 Oct/min, 1 hr / Per Axis
Shock During Operation	Operation: IEC 60068-2-29, 50 Grms, half sine, 11 ms duration
Packaging Content	Carton size: 360 x 306 x 220 (mm) Packing Capacity: 5pcs Single Box size: 286 x 178 x 66 (mm) Including: Power Cord : Optional (by region) PSU ADP 19V 65W 100-240VAC x 1 (P/N: 25EP0-1065W1-A3S) Wall mount bracket x 2 (P/N: 25HBA-G70020-U2R)
Order Information	System: 9BQMG700AMR-SI (Box packing)

Chapter 2

Chapter 2 – QM-G700A

2.1 Dimension

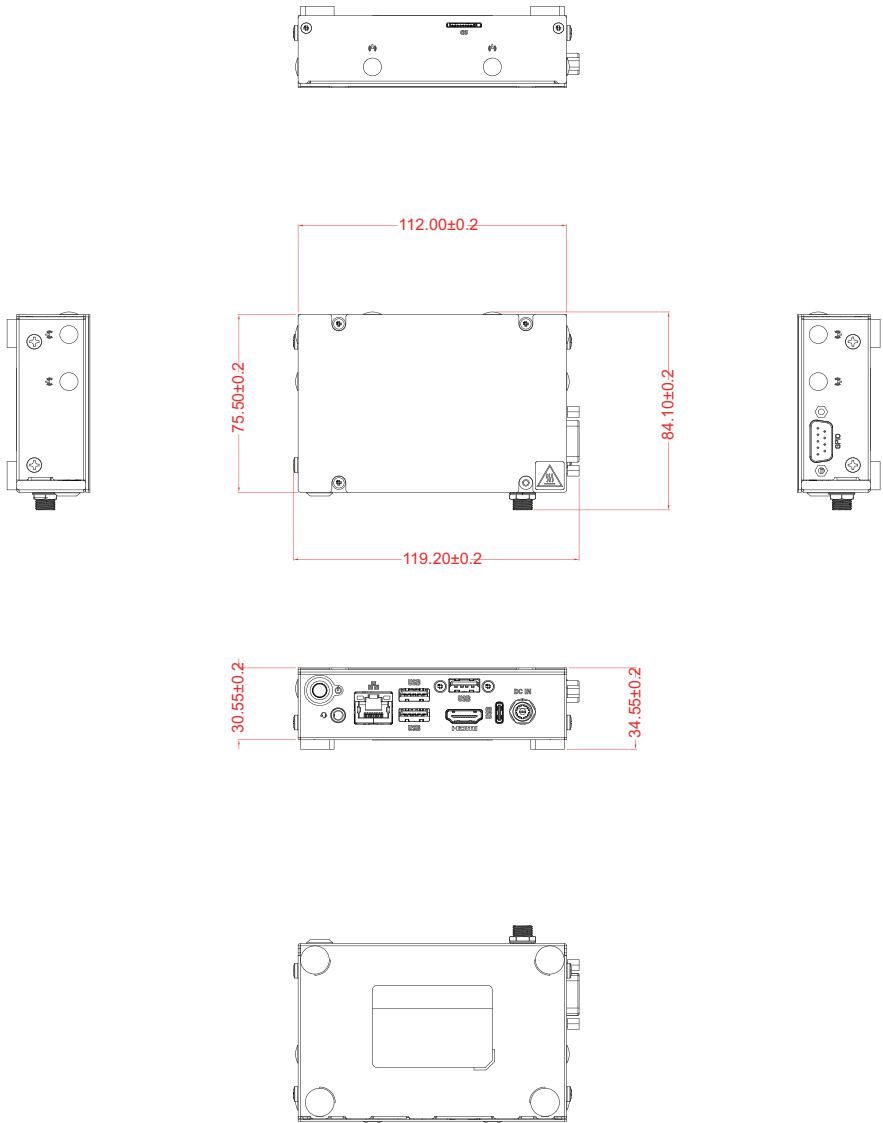

2.2 Getting Familiar with Your Unit

[Rear Side]

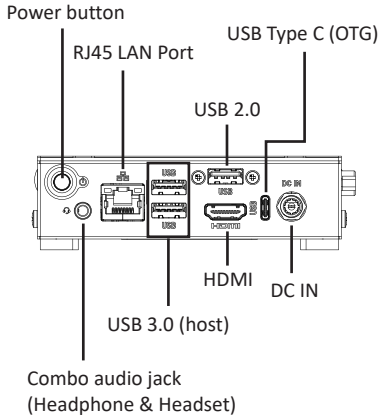

[Left Side]

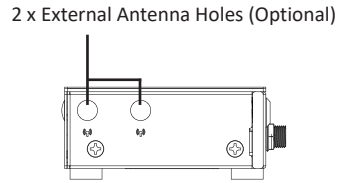

[Front Side]

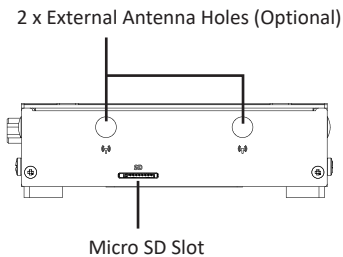

[Right Side]

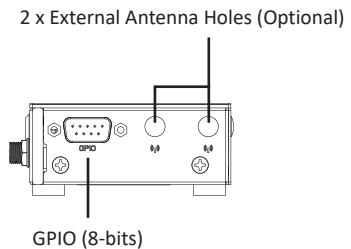

[Installation]

- * Before opening the case, make sure to unplug the power cord.
- * Before Connecting the power, make sure to fasten the case securely.

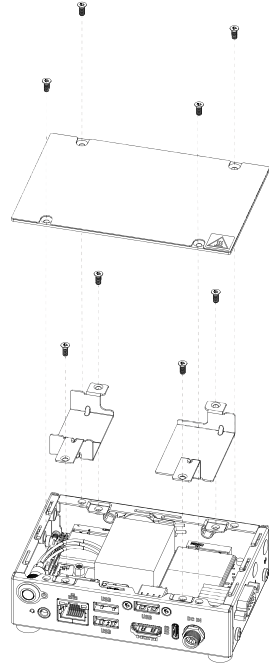

[Bottom PCB Side]

Information	
A	M.2 3052 B-Key connector
B	M.2 2230 E-Key connector

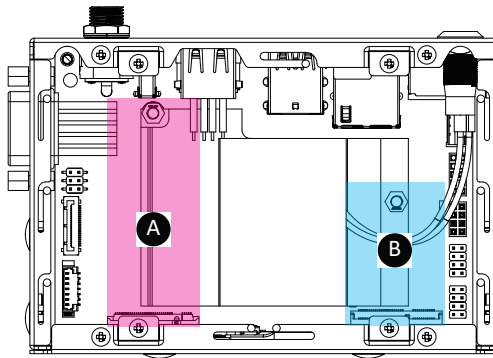

2.3 A) 5G module Installation: How to safely install the module (5G Module inclusion may vary based on local distribution)

1

Remove the screw from the screw hole.

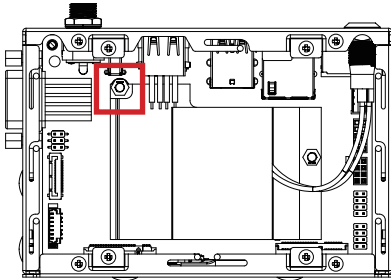
**2**

Carefully insert the 5G module into the slot, and secure with the screw.

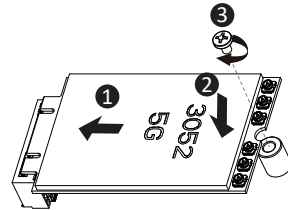

2.4 B) Wireless Module : How to safely install the Module (Wireless Module inclusion may vary based on local distribution)

1

Remove the screw from the screw hole.

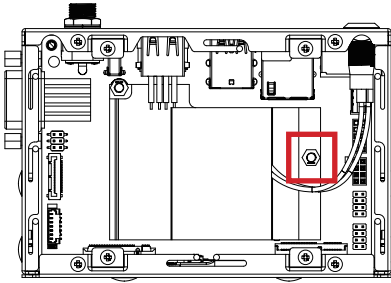

2

Carefully insert the wireless module into the M.2 slot.

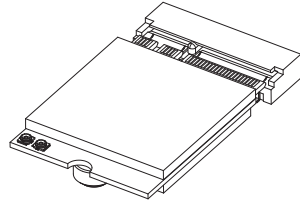

3

Lock the screw in the middle.

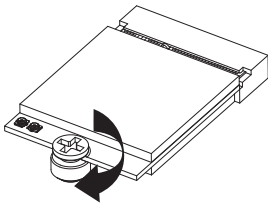

4

Install the antenna on the left side of the connection wireless module down.

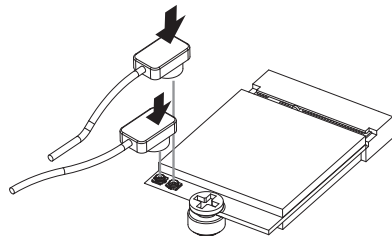

2.5 Antenna Installation (Antenna inclusion may vary based on local distribution)

1

Carefully insert the antennas into the connectors.

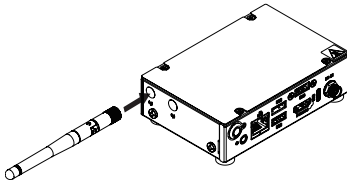
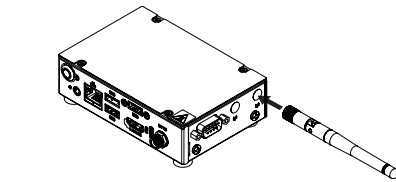
**2**

Turn the antennas clockwise until they are completely secure on the connectors.

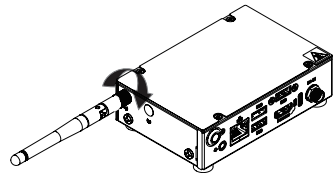
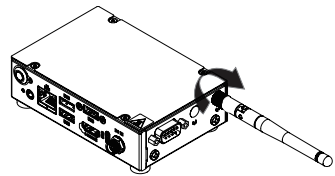
**3**

Flip up the antenna heads so that they are perpendicular to the machine.

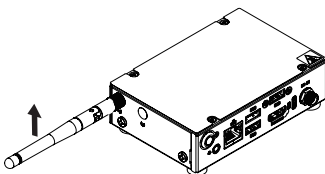
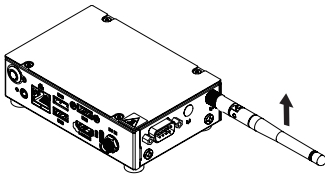

2.6 Wall mount Bracket Installation

1

Remove 4 screws on the rear side, then install wall mount brackets with those 4 screws.

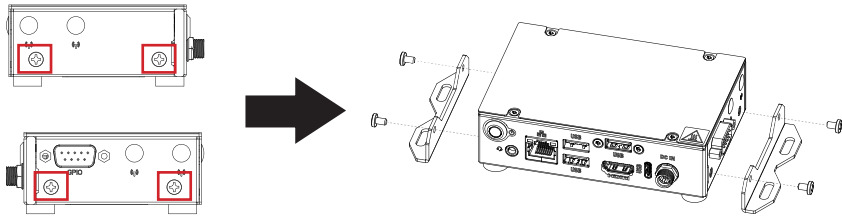

2

Suggest screws as below for different type of surface.

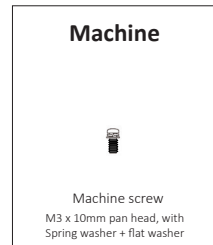
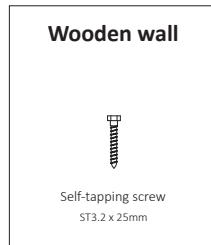
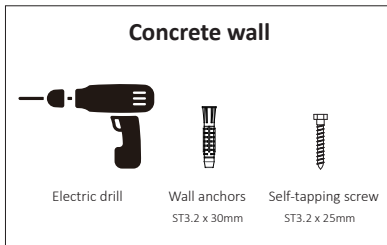

2.7 Cable Pin-define

1. DBP DIO (25CR5-070601-S9R)

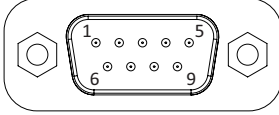

DBP DIO Pin	Pin Name
1	GPIO-output_1
2	GPIO-input_1
3	GPIO-output_2
4	GPIO-input_2
5	GPIO-output_3
6	GPIO-input_3
7	GPIO-output_4
8	GPIO-input_4
9	5V

2.8 Support

- For AVL list, go to: <http://www.gigaipc.com>
- To download the latest drivers, go to: <http://www.gigaipc.com>
- For product support, go to: <http://www.gigaipc.com>

2.9 Safety and Regulatory Information

Risk of explosion if the battery is replaced with an incorrect type. Batteries should be recycled where possible.

Disposal of used Batteries must be in accordance with local environmental regulations.

Failure to use the included Power Adapter may violate regulatory compliance and may expose the user to safety hazards.

HDMI™
HIGH DEFINITION MULTIMEDIA INTERFACE



At the end of its serviceable life, this product should not be treated as household or general waste. It should be handed over to the applicable collection point for the recycling of electrical and electronic equipment, or returned to the supplier for disposal.

Chapter 3

Chapter 3 – Hardware Information

3.1 Jumpers and Connectors

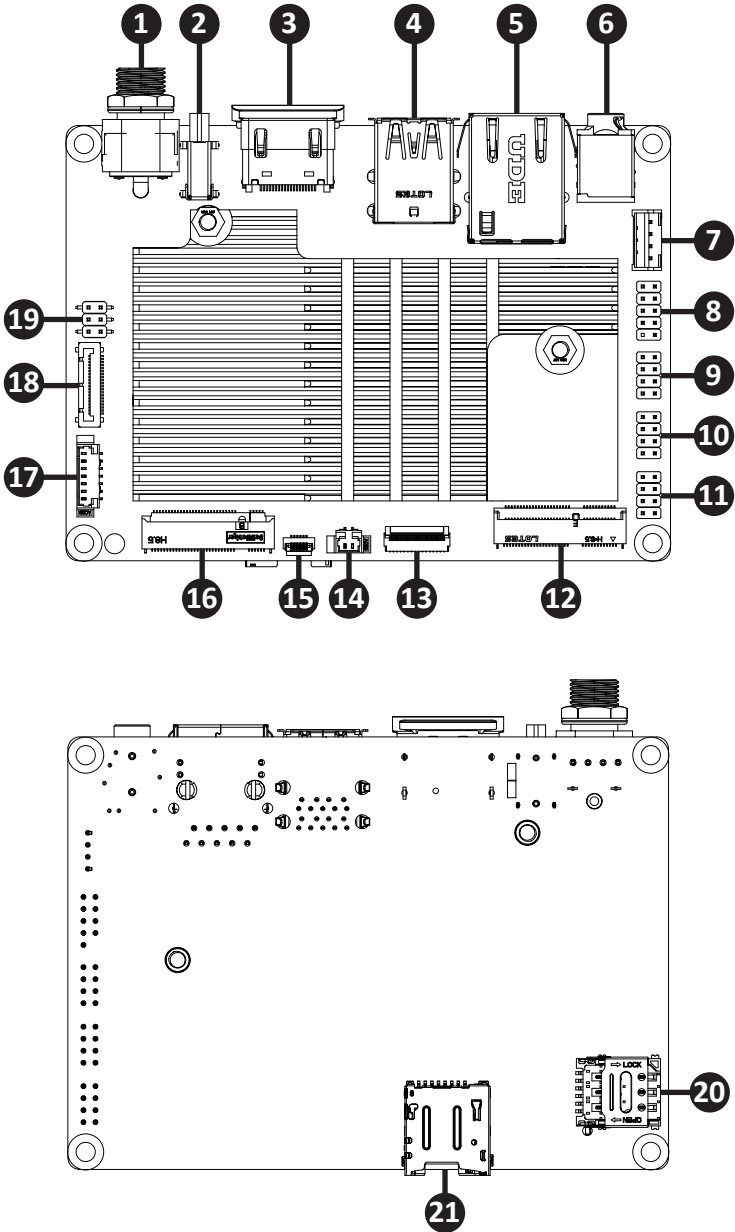

No	Code	Description
1	DC_IN4	DC IN connector
2	USB3C	USB Type C connector
3	HDMI	HDMI connector
4	USB3	USB 3.0 connector
5	LAN	LAN connector
6	HP	Combo audio jack (Headphone & Headset)
7	SPK_OUT	Speaker out connector
8	FUSB	USB 2.0 headers
9	SYS_PANEL	Front panel header
10	GPIO	General purpose input / ouput header
11	UART	UART connector
12	M2E	M.2 Slot, 2230 E-key, Secure digital input/output interface (SDIO)
13	MIPI	Mobile Industry Processor Interface
14	BAT	Battery cable connector
15	MIPI_CON	MIPI touch connector
16	M2B	M.2 Slot, 3052 B-key
17	EDP_PWR	eDP power header
18	EDP	eDP connector
19	SPI	OTG select jumper
20	SIM_CARD	Nano SIM card slot
21	SD	Micro SD card slot

3.2.1 DC_IN4 (DC IN connector)

1

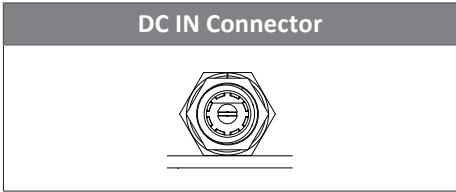
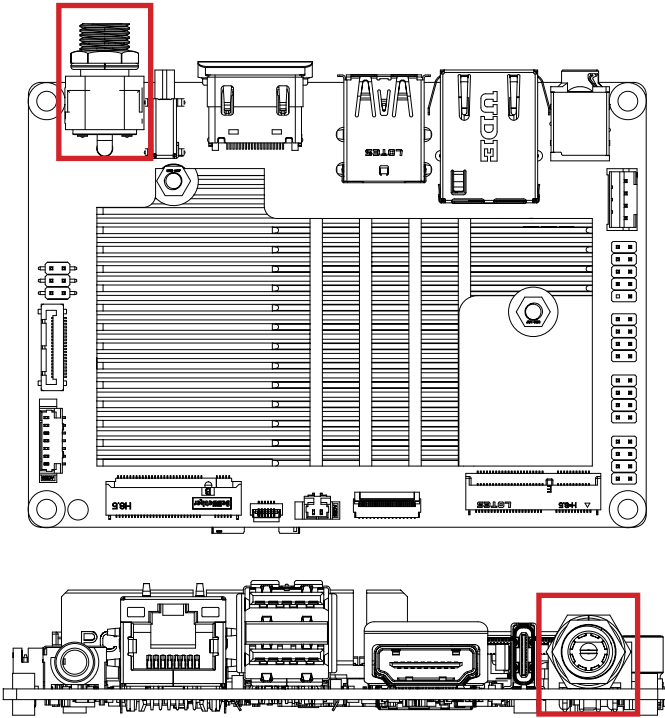

Connector PN	Vendor
655-360-000	SHEN-MING

3.2.2 USB3C (USB Type C connector)

2

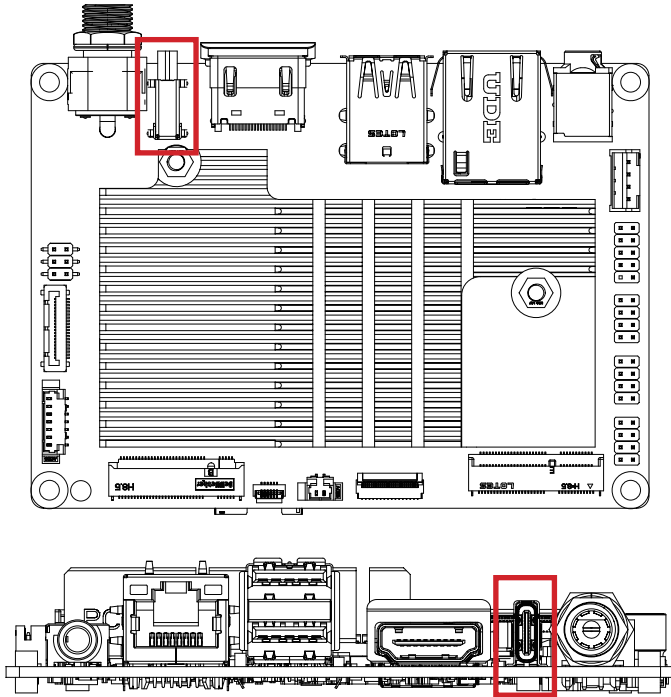

USB Type C Connector



Connector PN

WU3CR-24A5L1CU5T41

Vendor

WINWIN

Pin No.	Definition	Pin No.	Definition
A1	GND	B1	GND
A2	TX1+	B2	TX2+
A3	TX1-	B3	TX2-
A4	VBUS	B4	VBUS
A5	CC1	B5	CC2
A6	D+	B6	D+
A7	D-	B7	D-
A8	NC	B8	NC
A9	VBUS	B9	VBUS
A10	RX2-	B10	RX1-
A11	RX2+	B11	RX1+
A12	GND	B12	GND

3.2.3 HDMI (HDMI connector)

3

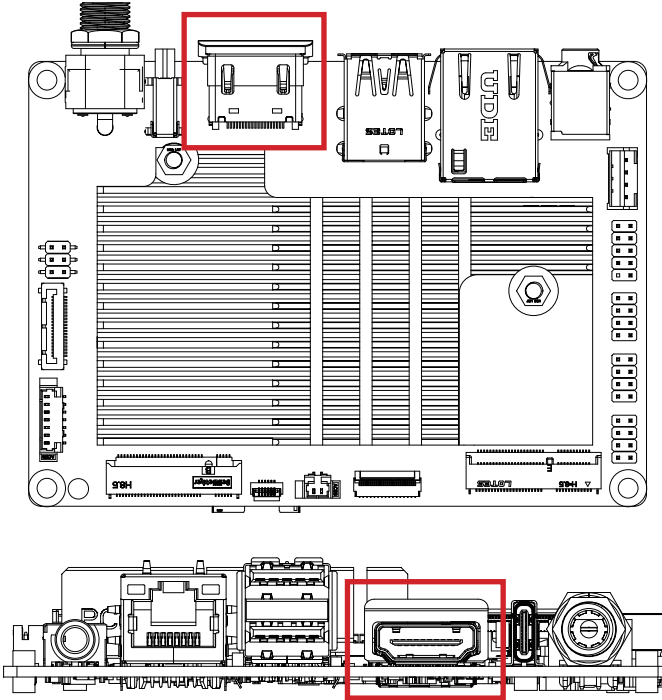

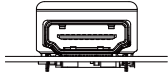
HDMI Connector	
	

Connector PN	Vendor
1165-2CG04-24P	TCONN

Pin No.	Definition	Pin No.	Definition
1	HDMI_D2p	11	GND
2	GND	12	HDMI_CLKn
3	HDMI_D2n	13	CEC
4	HDMI_D1p	14	NC
5	GND	15	HDMI_SCL
6	HDMI_D1n	16	HDMI_SDA
7	HDMI_D0p	17	GND
8	GND	18	5V
9	HDMI_D0n	19	HDMI_HPD
10	HDMI_CLKp		

3.2.4 USB3 (USB 3.0 connector)

4

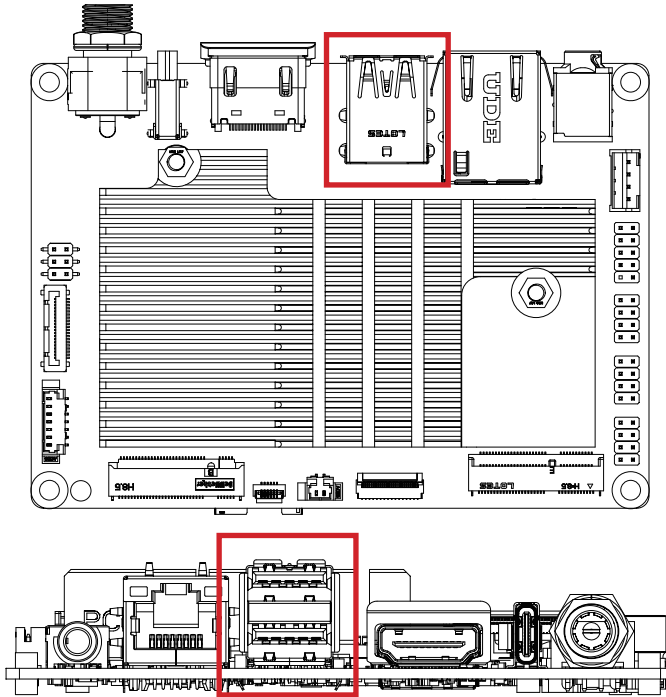

USB 3.0 Connector



Connector PN	Vendor
UEA11121-8FS6-4F	FOXCONN
ABA-USB-079-K01	LOTES

Pin No.	Definition	Pin No.	Definition
1	5V	10	5V
2	USB_D-	11	USB_D-
3	USB_D+	12	USB_D+
4	GND	13	GND
5	USB3_RX-	14	USB3_RX-
6	USB3_RX+	15	USB3_RX+
7	GND	16	GND
8	USB3_TX-	17	USB3_TX-
9	USB3_TX+	18	USB3_TX+

3.2.5 LAN (LAN connector)

5

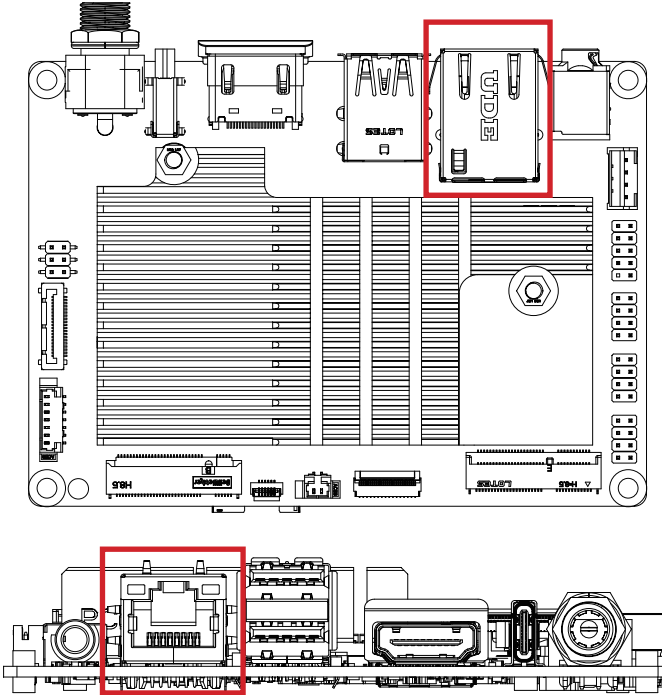

LAN Connector

1 8

Link / Activity LED Connection / Speed LED

Pin No.	Definition
1	MD0p
2	MD0n
3	MD1p
4	GND
5	GND
6	MD1n
7	GND
8	GND

State	Description
Orange On	1Gbps data rate
Green On	100Mbps data rate
Off	10Mbps data rate

Connector PN	Vendor
RT7-GB-0002	UDE

3.2.6 HP (Combo audio jack (Headphone & Headset))

6

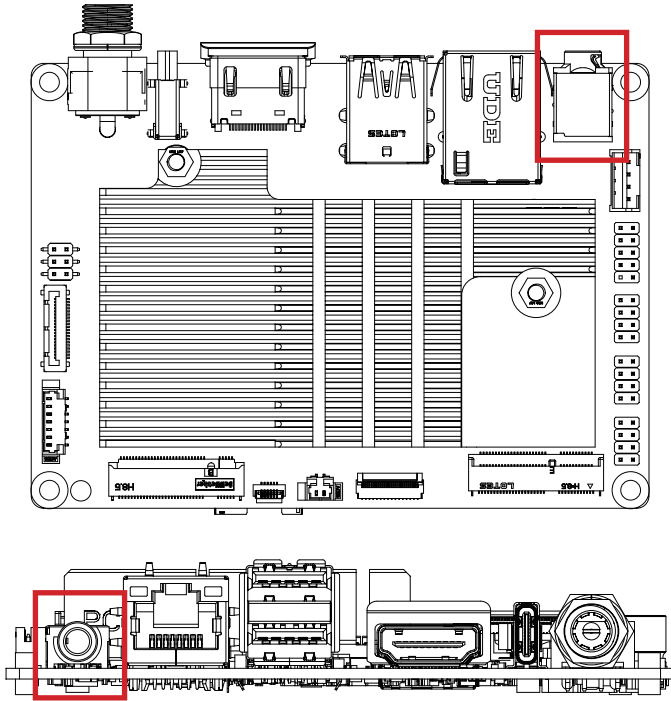

3.2.7 SPK_OUT (Speaker out connector)

7

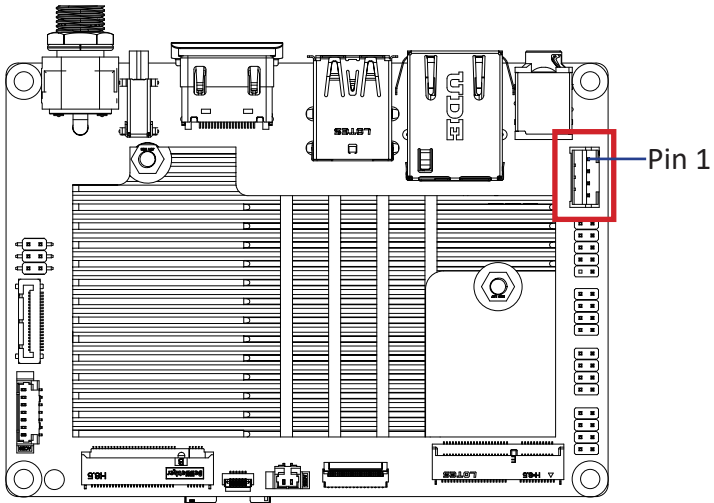

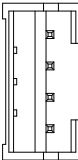
Speaker out Connector	
	1 4

Connector PN	Vendor
A2001WV-04P146	JOINT-TECH
Connector type	
1x4pin header, pitch 2.0mm	

Pin No.	Definition
1	Speaker Out L+
2	Speaker Out L-
3	Speaker Out R-
4	Speaker Out R+

3.2.8 FUSB (USB 2.0 headers)

8

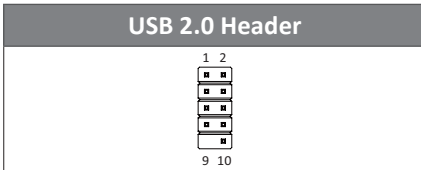
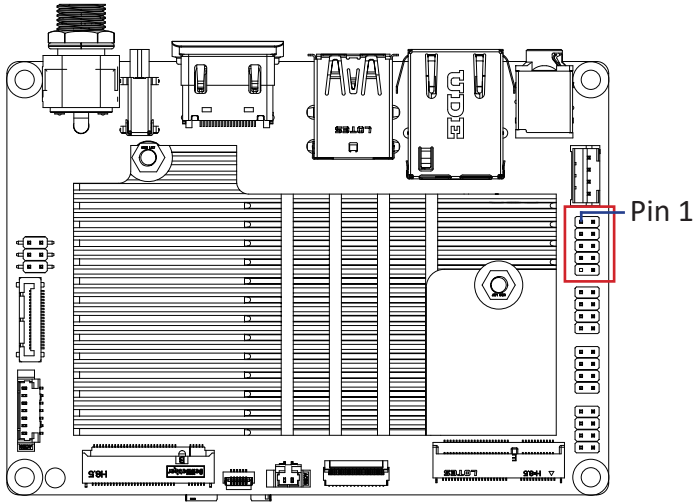

Pin No.	Definition
1	5V
2	5V
3	DXn
4	DYn
5	DXp
6	DYp
7	GND
8	GND
9	No Connect
10	No Pin

Connector PN	Vendor
220-97-05GB19	PINREX
PH10N53BAZ009	HORNGTONG

Connector type
2x5pin header, pitch 2.0mm

3.2.9 SYS_PANEL (Front panel header)

9

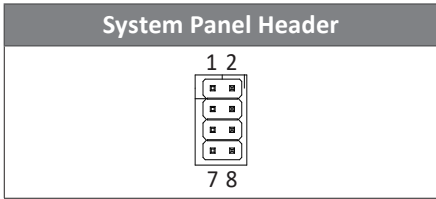
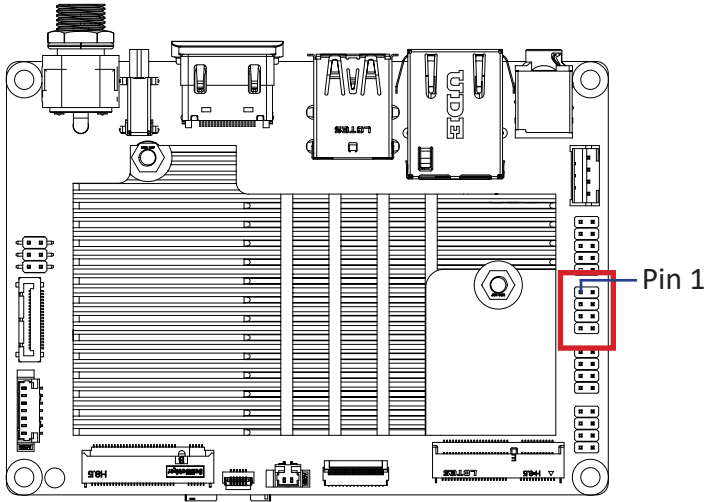

Connector PN	Vendor
220-97-04GB01	PINREX

Connector type
2x4pin header, pitch 2.0mm

Pin No.	Definition
1	Power key
2	GND
3	System reset
4	GND
5	Download Key
6	GND
7	HOME Key
8	Power LED

3.2.10 GPIO_CNT (General Purpose input/output header)

10

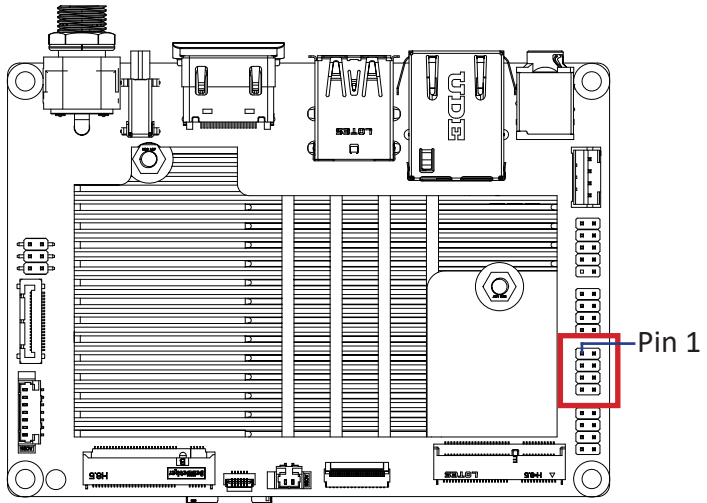

GPIO Connector

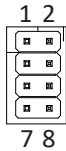

Pin No.	Definition
1	GPIO0
2	GPIO4
3	GPIO1
4	GPIO5
5	GPIO2
6	GPIO6
7	GPIO3
8	GPIO7

Connector PN

220-97-04GB01

Vendor

PINREX

Connector type

2x4pin header, pitch 2.0mm

3.2.11 UART (UART connector)

11

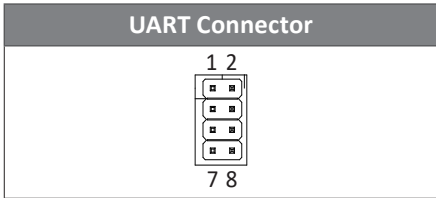
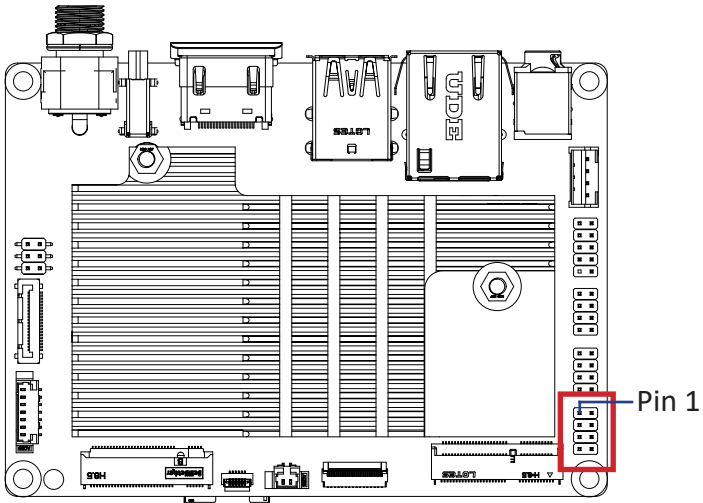

Connector PN	Vendor
220-97-04GB01	PINREX
Connector type	
2x4pin header, pitch 2.0mm	

Pin No.	Definition
1	+3.3V
2	+3.3V
3	TXD0
4	TXD1
5	RXD0
6	RXD1
7	GND
8	GND

3.2.12 M2E (M.2 Slot, 2230 E-key, Secure digital input/output interface (SDIO))

12

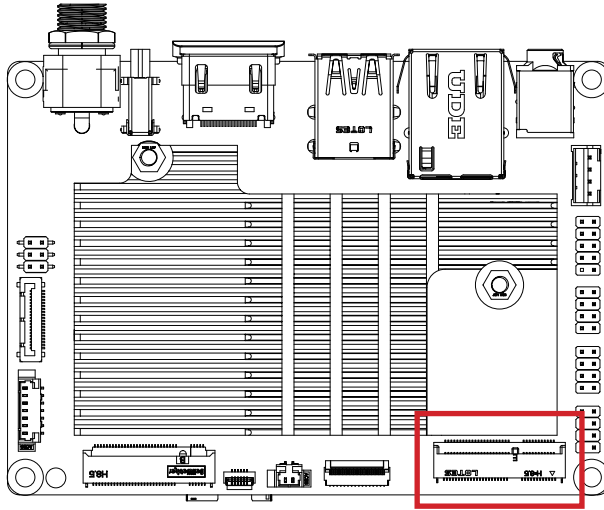

M.2 E Key Connector

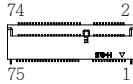

Pin No.	Definition	Pin No.	Definition
1	GND	2	3V
3	NC	4	3V
5	NC	6	NC
7	GND	8	NC
9	NC	10	NC
11	NC	12	NC
13	NC	14	NC
15	NC	16	NC
17	NC	18	GND
19	NC	20	1.8V
21	NC	22	1.8V
23	SDIO_DS		

Pin No.	Definition	Pin No.	Definition
33	GND	32	NC
35	SDIO_D1	34	NC
37	SDIO_D0	36	NC
39	GND	38	NC

41	SDIO_Clock	40	NC
43	SDIO_Command	42	NC
45	GND	44	I2S_DI
47	SDIO_D3	46	I2S_D0
49	SDIO_D2	48	I2S_Bitclock
51	GND	50	I2S_LRCK
53	Clock request	52	I2S_PERST
55	WiFi_INT	54	NC
57	GND	56	NC
59	NC	58	NC
61	NC	60	NC
63	GND	62	NC
65	NC	64	NC
67	NC	66	NC
69	GND	68	NC
71	NC	70	NC
73	NC	72	3V
75	GND	74	3V

Connector PN	Vendor
APCI0095-P002A	LOTES
80152-8521	BELLWETHER
2E0BC21-S85BE-LH	FOXCONN

3.2.13 MIPI (Mobile Industry Processor Interface)

13

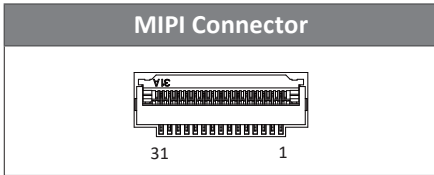
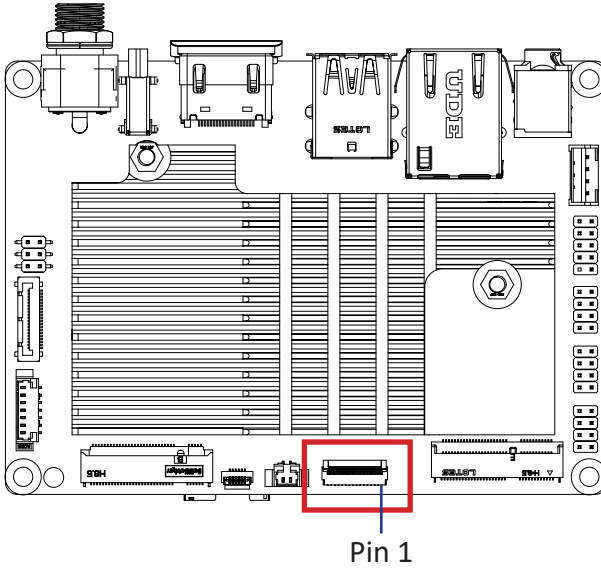

Pin No.	Definition	Pin No.	Definition
1	1.8V	17	CKN
2	BL_EN	18	GND
3	GND	19	D0P
4	GND	20	D0N
5	+5V	21	GND
6	+5V	22	D3P
7	NC	23	D3N
8	LCM_RST	24	GND
9	GND	25	NC

Pin No.	Definition	Pin No.	Definition
10	D2P	26	LCM_BL_EN
11	D2N	27	GND
12	GND	28	+5V
13	D1P	29	+5V
14	D1N	30	+5V
15	GND	31	+5V
16	CKP		

Connector PN	Vendor
FH35C-31S-0.3SHW(50)	HRS

Connector type
1x31pin header, pitch 0.3mm

3.2.14 BAT (Battery cable connector)

14

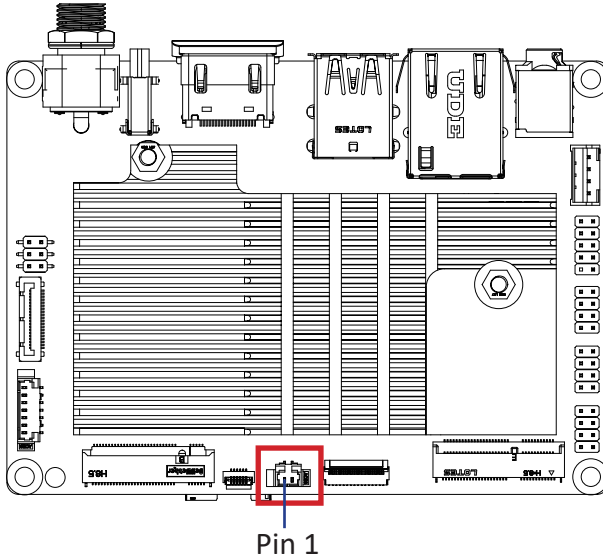

Battery cable Connector

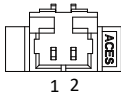

Pin No.	Definition
1	3.3V
2	GND

Connector PN

Vendor

85205-0270L

ACES

A1250WV-S-02PC

JOINT-TECH

Connector type

1x2pin header, pitch 1.25mm

3.2.15 MIPI_CON (MIPI touch connector)

15

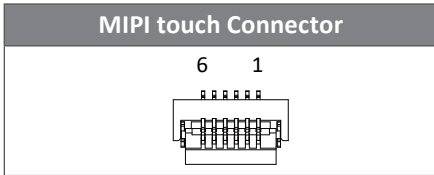
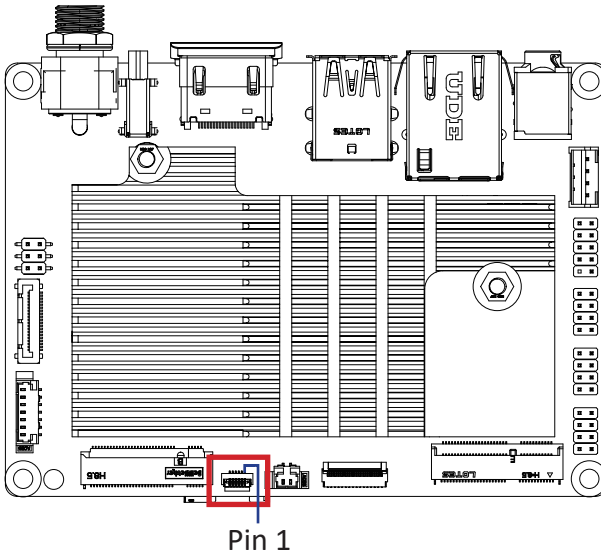

Pin No.	Definition
1	GND
2	SDA
3	SCL
4	EINT_CTP
5	GPIO_CTP_RSTB
6	+3.3V

Connector PN	Vendor
51536-00641-001	ACES
Connector type	
1x6pin header, pitch 0.5mm	

3.2.16 M2B (M.2 Slot, 3052 B-key)

16

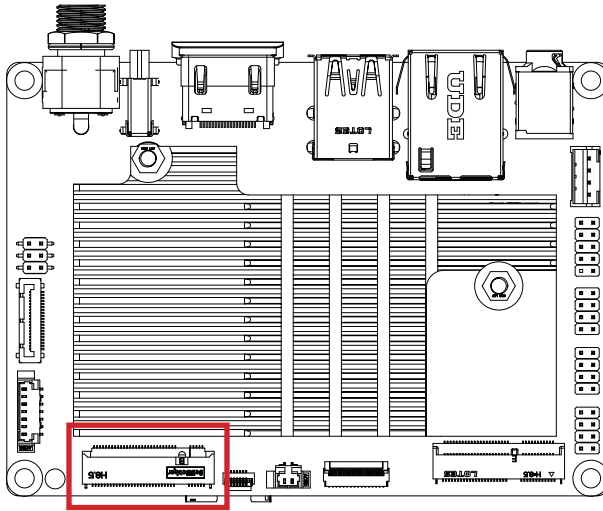

M.2 B Key Connector

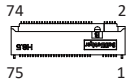

Pin No.	Definition	Pin No.	Definition
1	3.3V	2	3.3V
3	GND	4	3.3V
5	GND	6	3.3V
7	USB D+	8	NC
9	USB D-	10	LED
11	GND		

Pin No.	Definition	Pin No.	Definition
21	NC	20	NC
23	M2B_WAKE	22	NC
25	M2B_DRP	24	NC
27	GND	26	WWAN_Disable2
29	USB3_RXN	28	NC
31	USB3_RXP	30	SIM_RST#
33	GND	32	SIM_CLK
35	USB3_TXN	34	SIM_DATA
37	USB3_TXP	36	SIM_PWR
39	GND	38	BootSelect

Pin No.	Definition	Pin No.	Definition
41	NC	40	NC
43	NC	42	NC
45	GND	44	NC
47	NC	46	GNSS_CLK
49	NC	48	GNSS_TX_BLANK
51	GND	50	PLT_RST
53	NC	52	CK_REQ
55	NC	54	PCIE_WAKE
57	GND	56	NC
59	NC	58	NC
61	NC	60	COEX3
63	NC	62	COEX2
65	NC	64	COEX1
67	1.8V	66	UMI_DET
69	M2B_DET	68	NC
71	GND	70	3.3V
73	GND	72	3.3V
75	NC	74	3.3V

Connector PN	Vendor
80149-8521	BELLWETHER
2E0BC21-S85BB-7H	FOXCONN

3.2.17 EDP_PWR (eDP power header)

17

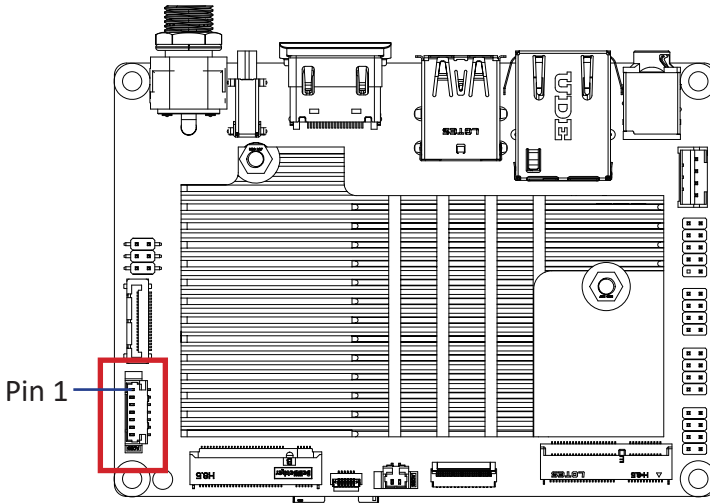

eDP power connector	
1	
7	

Pin No.	Definition
1	NC
2	NC
3	3V
4	GND
5	GND
6	12V
7	12V

Connector PN	Vendor
85205-0770N	ACES

Connector type
1x7pin header, pitch 1.25mm

3.2.18 EDP (eDP connector)

18

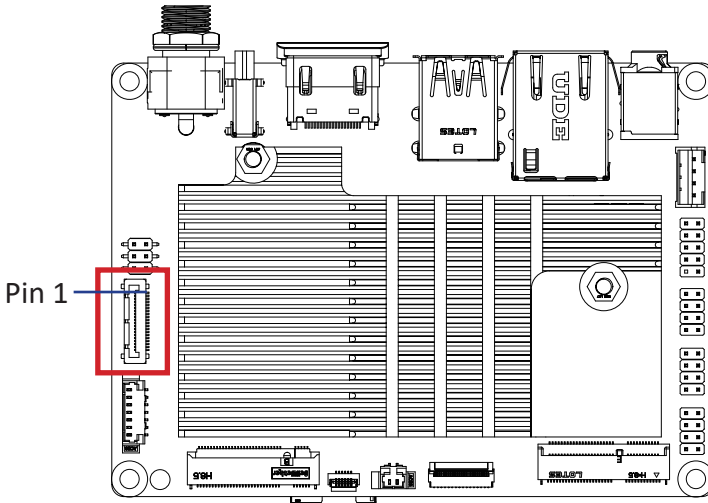

Embedded Display Port Connector

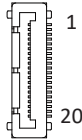

Pin No.	Definition	Pin No.	Definition
1	GND	11	NC
2	EDP_TX0-	12	NC
3	EDP_TX0+	13	GND
4	GND	14	EDP_AUX-
5	EDP_TX1-	15	EDP_AUX+
6	EDP_TX1+	16	GND
7	GND	17	Hotplug Detect

Pin No.	Definition	Pin No.	Definition
8	NC	18	Backlight Enable
9	NC	19	GND
10	GND	20	Backlight cotrol

Connector PN	Vendor
115B20-100020-G4-R	STARCONN

Connector type
1x20pin header, pitch 0.5mm

3.2.19 SPI (OTG select jumper)

19

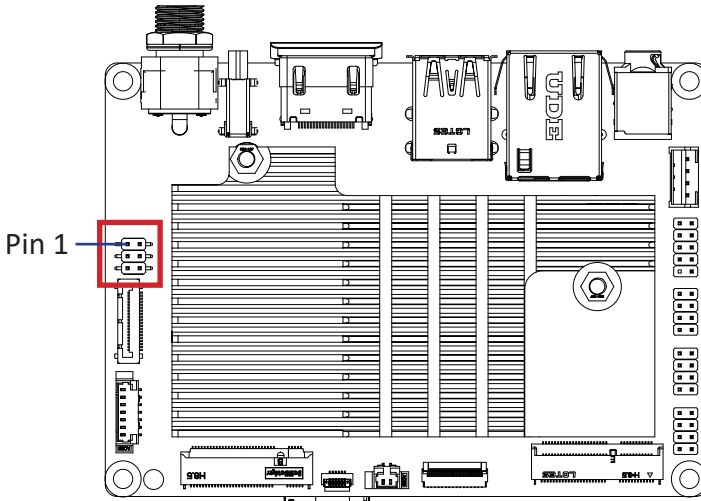

OTG select jumper	
1	2
5	6

Connector PN	Vendor
222-97-03GBE1	PINREX
Connector type	
2x3pin header, pitch 2.0mm	

OTG Jumper Select												
<table border="1"> <tr><td>1</td><td>2</td></tr> <tr><td>□</td><td>□</td></tr> <tr><td>□</td><td>□</td></tr> <tr><td>5</td><td>6</td></tr> </table>	1	2	□	□	□	□	5	6	5-6 Open: Charging mode	The system is configured as a charging device.		
1	2											
□	□											
□	□											
5	6											
<table border="1"> <tr><td>1</td><td>2</td></tr> <tr><td>□</td><td>□</td></tr> <tr><td>□</td><td>□</td></tr> <tr><td>■</td><td>■</td></tr> <tr><td>5</td><td>6</td></tr> </table>	1	2	□	□	□	□	■	■	5	6	5-6 Close: Master Mode (Host)	The system is configured as a host to connect USB 2.0 / USB 3.0 peripherals. (such as keyboards, mice, or USB flash drives)
1	2											
□	□											
□	□											
■	■											
5	6											

3.2.20 SIM_CARD (Nano SIM card slot)

20

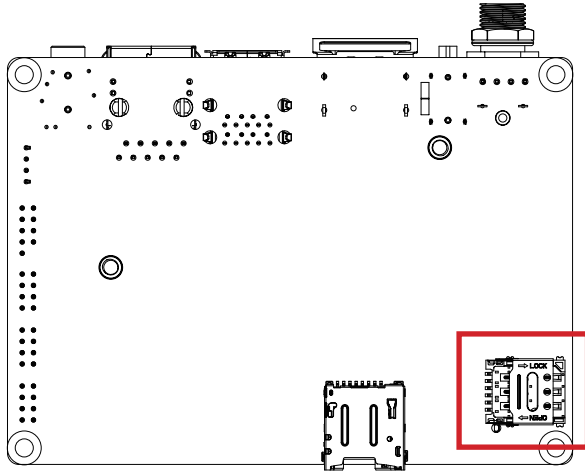

3.2.21 SD (Micro SD card slot)

21

